

# Instruction manual

Leak meter with camera

LD 500 / LD 510



# 1 Table of Content

<b>2</b>	<b>FOREWORD .....</b>	<b>4</b>
<b>3</b>	<b>SAFETY INSTRUCTIONS.....</b>	<b>5</b>
3.1	ABOUT THIS DOCUMENT .....	5
3.2	ENSURING SAFETY.....	5
3.3	ENVIRONMENTAL PROTECTION.....	5
<b>4</b>	<b>GENERAL FUNCTION DESCRIPTION.....</b>	<b>6</b>
<b>5</b>	<b>TECHNICAL DATA LD500.....</b>	<b>7</b>
<b>6</b>	<b>PROCEDURE LEAK DETECTION / MEASUREMENT.....</b>	<b>8</b>
<b>7</b>	<b>DEVICE COMPONENTS AND CONTROLS.....</b>	<b>9</b>
7.1	LD 500 .....	9
7.2	PRE AMPLIFIER MODULE .....	10
7.3	ACOUSTIC TRUMPET WITH CAMERA.....	10
7.4	FOCUS TUBE WITH FOCUS TIP .....	11
7.5	GOOSENECK (OPTIONAL).....	11
7.6	PARABOLIC MIRROR (OPTIONAL).....	11
7.7	ASSEMBLY WITH ACOUSTIC TRUMPET .....	12
7.8	ASSEMBLY WITH FOCUS TUBE WITH FOCUS TIP.....	12
7.9	ASSEMBLY WITH GOOSENECK .....	13
7.10	ASSEMBLY WITH PARABOLIC MIRROR.....	13
<b>8</b>	<b>COMMISSIONING / APPLIKATION LD 500 .....</b>	<b>14</b>
8.1	SWITCH ON .....	14
8.2	HEADPHONE VOLUME LOUD / VOLUME DOWN .....	14
8.3	SENSITIVITY LEVEL.....	14
8.4	LASER ON/OFF .....	14
<b>9</b>	<b>OPERATION .....</b>	<b>15</b>
9.1	INITIALIZATION.....	15
9.2	SCREEN LECKAGE.....	16
9.3	HOME MENU LD 500 .....	17
9.3.1	<i>Configuration of LD500.....</i>	<i>18</i>
9.3.1.1	Sensortype selection (Measuring tool).....	19
9.3.2	<i>Sensitivity levels .....</i>	<i>21</i>
9.3.3	<i>Storing of the measurement .....</i>	<i>21</i>
9.3.3.1	Parameter / Meas. Point (Re-Check) .....	22
9.3.3.2	Comment.....	23
9.3.3.3	Storing measurement data to internal SD-card.....	23
9.4	EXPORT/IMPORT.....	24
9.4.1	<i>Export.....</i>	<i>25</i>
9.4.1.1	Export „Journal Data“ .....	25
9.4.1.2	Export of System settings .....	26
9.4.2	<i>Import .....</i>	<i>27</i>
9.4.2.1	Import of system settings.....	27
9.4.2.2	Import new measurement tool .....	28
9.4.3	<i>Export / Import Customer database .....</i>	<i>29</i>
9.5	VIEW BITMAPS.....	30



9.6	DEVICE SETTINGS .....	31
9.6.1	<i>Passwort-Einstellung</i> .....	31
9.6.2	<i>Device Settings</i> .....	32
9.6.2.1	Language.....	32
9.6.2.2	Date & Time.....	33
9.6.2.3	SD-Card.....	33
9.6.2.4	System update.....	34
9.6.2.5	Factory Reset.....	35
9.6.2.6	Calibration of touchpanel .....	36
9.6.3	<i>Set backlight brightness</i> .....	37
9.6.4	<i>Cleaning</i> .....	38
9.6.5	<i>System-Status</i> .....	38
9.6.6	<i>About LD 500</i> .....	38
<b>10</b>	<b>CHARGING THE BATTERIES</b> .....	<b>39</b>
<b>11</b>	<b>D 510</b> .....	<b>40</b>
11.1	SELECTION EXTERNAL SENSOR .....	40
11.2	INPUT SIGNALS OF EXT. SENSOR LD510 .....	41
11.3	CABLE CROSS SECTION .....	41
11.3.1	<i>Sensor circuit points/Output signal:</i> .....	41
11.4	CONNECTION DIAGRAMS FOR DIFFERENT SENSOR TYPES.....	42
11.4.1	<i>Connector pin assignment for all sensors at PI 500</i> .....	42
11.4.2	<i>Connection for CS dew point- and consumption sensors, series FA/VA 5xx</i> .....	43
11.4.3	<i>Connection with RS485</i> .....	43
11.4.4	<i>Three- and four-wire power supply 0 - 1/10/30 VDC</i> .....	43
11.4.5	<i>Analogue two-, three-, and four-wire current signal</i> .....	44
11.4.6	<i>Two-, three- and four-wire connector pin assignments for PT100/PT1000/KTY81</i> .....	45
11.5	DEW POINT SENSOR FA 500 / FA 510 (RS 485 MODBUS).....	46
11.5.1	<i>Settings Dew point sensor FA 500 / FA 510</i> .....	47
11.5.1.1	Unit selection for temperature and humidity.....	47
11.5.1.2	Definition of the System pressure (relative pressure value).....	47
11.5.1.3	Definition of Reference pressure (absolute pressure value) .....	48
11.5.1.4	Calibration .....	48
11.5.1.5	More Settings Analogue output 4-20mA .....	49
11.6	FLOW SENSOR OF TYPE VA 500 / VA 520 / VA 550 / VA 570 (RS 485 MODBUS) .....	50
11.6.1	<i>Settings for Flow sensor VA 5xx</i> .....	51
11.6.1.1	Diameter settings (only for VA 500 or VA 550).....	51
11.6.1.2	Gas Constant settings .....	52
11.6.1.3	Definition of the reference conditions .....	53
11.6.1.4	Definition Unit of flow and velocity.....	53
11.6.1.5	Definition consumption counter value and consumption unit.....	54
11.6.1.6	Settings analogue output 4-20mA of VA 5xx .....	55
11.6.1.7	Settings Pulse / Alarm output of VA 5xx .....	56
11.6.1.8	Settings ZeroPoint or Low Flow Cut off for VA 5xx .....	58
11.7	TYPE MODBUS .....	59
11.7.1	<i>Selection and activation of Sensor-Type Modbus</i> .....	59
11.7.1.1	Modbus Settings.....	59
11.8	DATA LOGGER SETTINGS .....	63
<b>12</b>	<b>SCOPE OF DELIVERY</b> .....	<b>67</b>
<b>13</b>	<b>APPENDIX</b> .....	<b>68</b>

## 2 Foreword

Dear Customer,

thank you for purchasing our leak meter with camera **LD 500**.

The new leak meter LD 500 with integrated camera and leakage calculation are ideal measuring instruments which help to find and document even smallest leakages (0.1 l/min corresponds to approx. 1 € p. a.) easily even in far distances.

The **LD 510** is the worldwide first leak meter with an additional freely assignable sensor input for all CS sensors. In addition to the leakage measurement and detection also all necessary measurements concerning dew point, flow, pressure, and temperature ... can be carried out

### Main functions:

- **Tracking and location of leaks**

- compressed air, gas, steam and vacuum systems
- condensate drain
- seals
- refrigeration systems

- **Documentation / storage of leaks with**

- Image of the leak position
- Date / Time
- Description of the leakage position with indication of company / department or hall / machine
- Size of the leak in litres / min (units adjustable)
- Leakage costs per year in € (currency freely definable)

**Remark:** By means of the additional available CS leak Reporter (Order No.: 0554 0105) detailed reports with summary totals, subtotals (departments / warehouses etc.) as well as history reports (for temporal / continuous improvements) could be created.

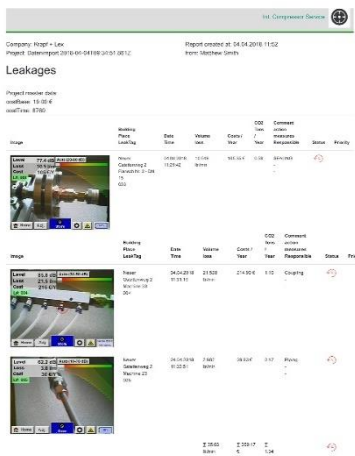





Image	Location	Date	Volume [l/min]	Cost [€]	Comment
	Plant 1	10.08.2016	10.00	100.00 €	Leakage
	Plant 2	10.08.2016	10.00	100.00 €	Leakage
	Plant 3	10.08.2016	10.00	100.00 €	Leakage



### 3 Safety instructions

#### 3.1 About this document

- Read carefully this documentation and familiarize yourself with the product before putting it to use. Pay particular attention to the safety warnings to prevent injury and product damage.
- Keep this documentation to hand for easy reference when needed.
- Pass on this documentation to any subsequent users of the product.

#### 3.2 Ensuring safety



- Only use the product as intended and within the parameters specified in the technical data. Do not use force for operating. Never measure with the device at or near live/energized parts!

During leak detection on electrical systems, please maintain a sufficient safety distance to avoid dangerous electric shocks!

- Avoid any direct contact with hot and/or rotating parts.
- Always switch on the device before putting on the headphones! At high signal levels (bar graph headphones in the red area), the volume can be correspondingly large. The sensitivity setting can be used to reduce the volume.
- Never point the laser directly into the eyes! Absolutely avoid a direct irradiation of the eyes of humans and animals!



Laser module: corresponds to DIN EN 60825-1: 2015-07 Class 2 (<1mW)

- Observe the prescribed storage and operating temperatures.
- Improper handling or violence will void the warranty.
- Any kind of interventions on the device, as far as they do not correspond to the intended and described procedures, lead to the warranty expiration and to the disclaimer.
- The device is intended solely for the described purpose.

#### 3.3 Environmental protection



- Disposal of faulty rechargeable batteries / empty batteries in accordance with applicable legal regulations
- Lead back the product after the end of the period of use to the separate collection for electric and electronic devices (observe local regulations) or return the product to CS Instruments GmbH & Co.KG for disposal.

**CS Instruments GmbH & Co.KG** makes no warranty as to its suitability for any particular purpose and assumes no liability for any errors contained in this manual. Nor for consequential damages in connection with the delivery, performance or use of this device.

## 4 General function description

When gases escape from leaks in piping systems (leaking screw connections, corrosion, etc.), noises are generated in the ultrasonic range. With the LD 500 even the smallest leaks, which are inaudible to the human ear and not visible due to their size, can be located several meters away.

The inaudible ultrasound is converted to audible frequencies in addition to the display emission level shown in the display. With the convenient, sound-proof headphones, these sounds can be heard even in noisy environments.

In addition, the new LD500 device calculates the costs associated with leaks, providing additional transparency about the state of the system under test or the potential cost savings.

The loss is displayed in l / min as well as in a freely selectable currency. The cost per litre or per cubic meter of compressed air can be stored in the device.

The professional measuring instrument LD500 finds typical application in leak detection in compressed air systems and leak testing of pressure less systems.

With the help of an integrated laser pointer, which serves as a targeting, the leak can be pinpointed.

Depending on the leakage, the appropriate accessories may be used to increase the sensitivity of the LD500 to use, available accessories are:

- |                             |  |
|-----------------------------|--|
| ▪ Acoustic trumpet          | For general measurements (0.2 - 6m) in directly accessible areas |
| ▪ Focus tube with focus tip | For punctual measurements in directly accessible areas           |
| ▪ Gooseneck                 | For punctual measurements in hard-to-reach areas                 |
| ▪ Parabolic mirror          | For leakage measurements (3m - 12m) at longer distances          |

## 5 Technical data LD500

Dimensions	263 x 96 x 280 mm (incl. PreAmp module and acoustic trumpet)
Weight	0,55 kg incl. PreAmp module and acoustic trumpet , complete set with transportation case ca.3,5 kg
Frequency range	40kHz (+/- 2kHz)
Power supply	Internal 7.4 V lithium-ion battery
Operating time	> 9 h (continuous operation)
Operating temperature	-5 °C to +40 °C
Charging	Ext. battery charger (included in the scope of delivery)
Charging time	approx. 1.5 h
Storage temperature	-20 °C to +50 °C
Laser	Wavelength 645-660nm, output < 1mW (Laser class 2)
Connections	3.5 mm jack for headphones, power jack for connecting an external charger USB Connection
Display	3.5"-Touchpanel TFT transmissiv
Interface	USB for data export / -import, SW update etc.
Datalogger	4 GB-Memory card (Micro SD Class 4)
Sensitivity	min: 0,1l/min at 6bar / 5m Distance

## 6 Procedure leak detection / measurement

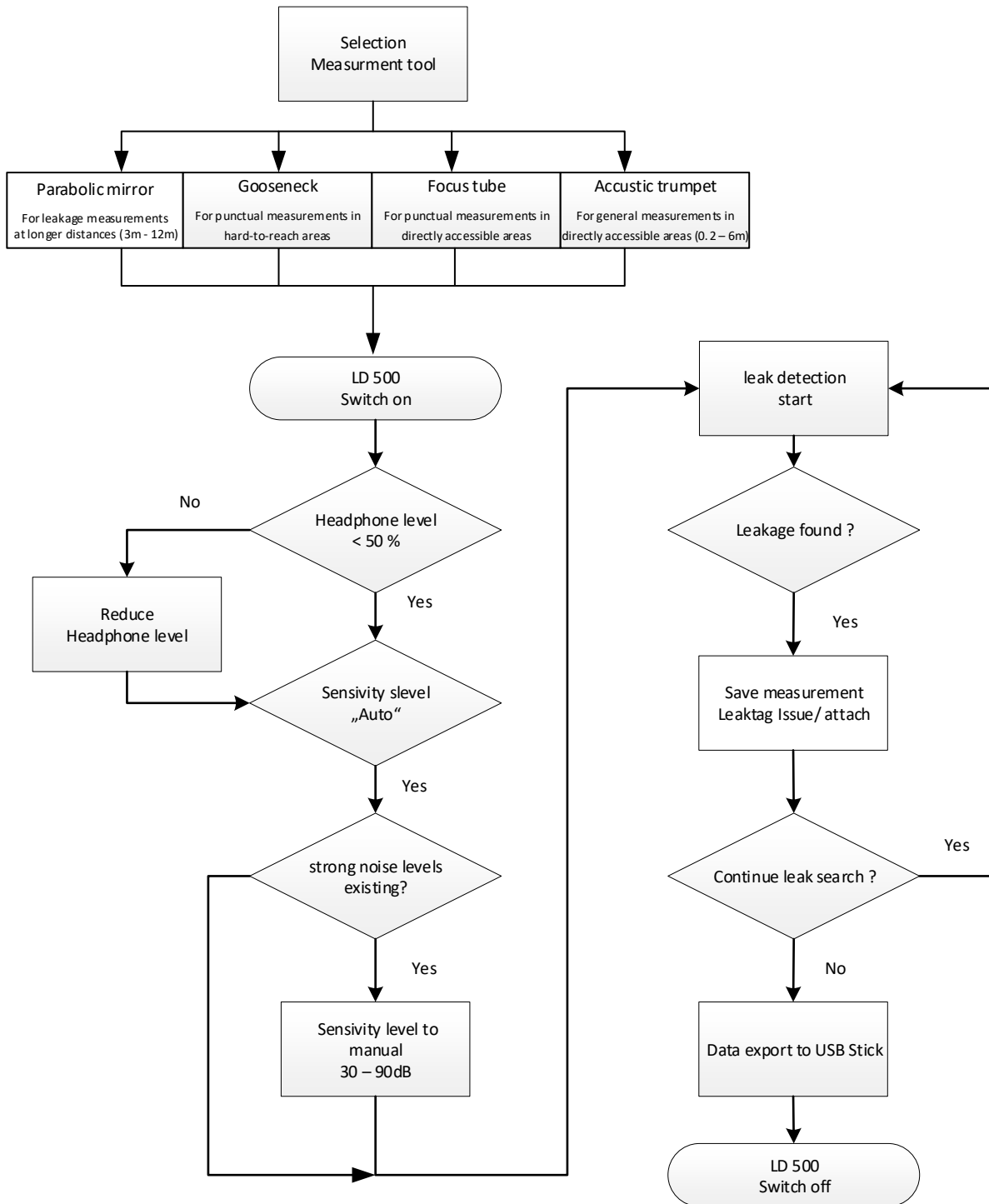



## 7 Device components and controls

### 7.1 LD 500



Picture 1



Picture 2

### 7.2 Pre Amplifier module



Picture 3

### 7.3 Acoustic trumpet with camera



Picture 4

**7.4 Focus tube with focus tip**



Picture 5

**7.5 Gooseneck (Optional)**



Picture 6

**7.6 Parabolic mirror (Optional)**



Picture 7

### 7.7 *Assembly with acoustic trumpet*

The acoustic trumpet allows acoustic amplification by bundling the sound waves and specifies the location of the leak. Due to the special construction of the integrated laser pointer is still usable. The camera is integrated on the bottom of the acoustic trumpet and is electrically connected to the preamplifier module via the jack plug.

Assembling is done by plugging the individual components until easy locking audible (plug in to the stop).

The components are removed in the reverse order; for unlocking the preamplifier module, the release button must also be pressed.



Picture 8

### 7.8 *Assembly with focus tube with focus tip*

The focus tube with focus tip is used to detect very small leaks, to accurately locate them.

Just like the acoustic trumpet, the tube can be plugged into the preamplifier with ultrasonic receiver. The use of the camera is **no longer** possible.

The components are removed in the reverse order; for unlocking the preamplifier module, the release button must also be pressed.



Picture 9

### 7.9 Assembly with Gosseneck

Due to its flexibility, the gooseneck tool is used for punctual measurements in hard-to-reach areas. Connection to the LD 500 is via the supplied spiral cable, see Figure 10.

It is **no longer** possible to use the camera.

To remove the component, remove the connection cable by pressing the release button on both sides and pulling off the cable.



Picture 10

### 7.10 Assembly with Parabolic mirror

The parabolic mirror is used for measurements at greater distances as well as for high requirements regarding selectivity and location of leakage positions.

Connection to the LD 500 is via the supplied spiral cable, see Figure 11.

To remove the component, remove the connection cable by pressing the release button on both sides and pulling off the cable.



Picture 11

**Note:** To use the parabolic mirror and gooseneck, these components must be activated in the LD 500 during initial commissioning in order to save the component-specific adjustment parameters. If this has not already been done ex-works, the data for this is supplied via USB stick. For the activation (parameter import), see chapter 10.2 "Export / Import".

## 8 Commissioning / Applikation LD 500

	Please first observe the safety instructions in section 3
---	---

### 8.1 Switch on

Hold down the power button for about 1 second, the power will turn on, and a start-up sequence will appear on the display. Pressing the button again switches the device off again.

On-Off button, see [device components and controls](#)

### 8.2 Headphone Volume Loud / Volume Down

The volume keys increase or decrease the volume in the headphone in 16 levels. Continuously pressing the button automatically increases / decreases the value.

Volume up / down buttons for headphone volume, see [device components and controls](#)



**Please make sure the headphone level is <50% before putting on the headphones.**

### 8.3 Sensitivity level

When starting a leak detection or after switching on the sensitivity level "Auto" should be selected. In the case of strong noise levels from the environment it can be switched to a manually adjustable gain level, see [chapter 8.3.2 „Setting of Sensitivity level“](#)

Automatic sensitivity level at measurement start: 10 – 70dB

### 8.4 Laser On/Off

The laser pointer can only be switched on or off via the laser on / off button  in the display (not via the membrane keypad). When switched on, the display shows a laser warning symbol.

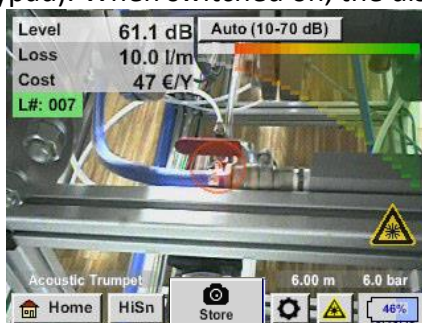

Laser „On“ Icon



**Please note the warnings for laser operation!  
Avoid direct / indirect (via reflexion) irradiation of the eyes in humans and animals!**

## 9 Operation

The operation is largely self-explanatory and menu-driven via the touch panel.

The selection of the respective menu items occur via short "tapping" with the finger or a soft round pen.

**Attention: Please use no pens or other objects with sharp edges!**  
**The foil can be damaged!**

Inputs or changes can be made with all white deposit fields

### 9.1 Initialization

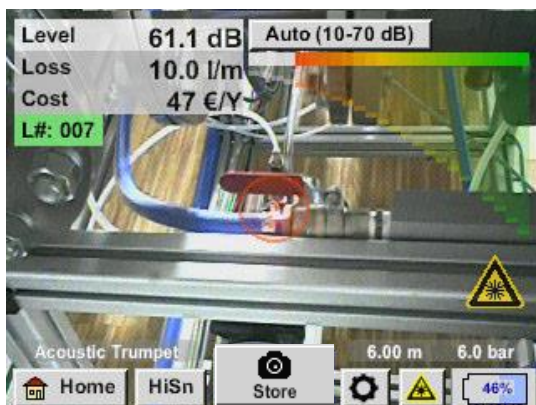

After switching on the LD 500, the initialization takes place and then switch to leakage display



## 9.2 Screen Leakage

The following picture shows and describes the display elements.

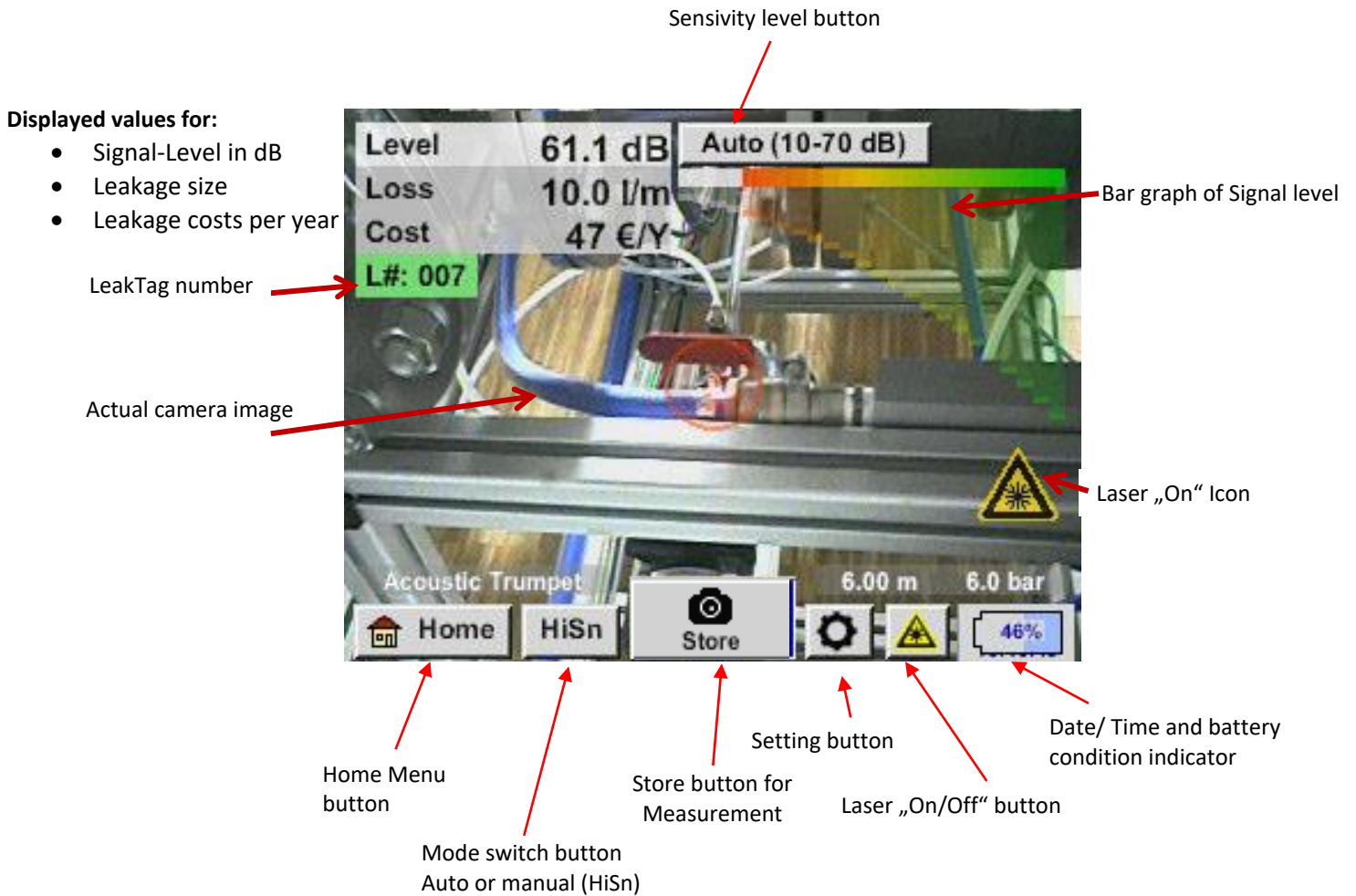

### Date / Time:

01.02.2018  
14:02:24

### Battery condition indicator

Battery condition:

Power supply connected and battery is charging:



### 9.3 Home menu LD 500

The operation is largely self-explanatory and menu-driven via the touch panel. The selection of the respective menu items occur via short "tapping" with the finger or a soft round pen.

**Attention: Please use no pens or other objects with sharp edges!**  
**The foil can be damaged!**

Before the leakage search is started, the device must be configured. The user can access the menu by clicking the "Home" button. The following figure shows the Home "Menu".



With the button „**Home**“ you access the basic menu of the LD 500.

Return to measurement by pressing „**Leakage**“ –button.

### 9.3.1 Configuration of LD500

Home → Configuration

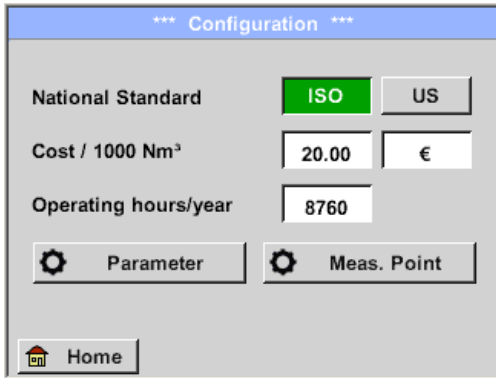

In the configuration settings the the unit system can be selected and the required parameters entered, this to calculate the leakage costs per year.

- Selection of ISO or US unit system
- Enter cost per 1000 volume units & Enter currency  
Default: 20 € / 1000 m<sup>3</sup>
- Enter working hours per year

Home → Configuration → Parameter



→ Sensor type  
Selection of the sensor type according to the application and ambient conditions, see therefor chapter 6.

- Pressure (line pressure in bar)
- Distance (distance to leakage in m)

Depending on the selected sensor type, there are up to 4 pre-defined pressure and distance values that can be selected directly as well as two fields (white) in which values for the pressure and the distance are freely selected..

The **pressure** can be set variably between 1 - 10 bar.

For the **different sensor types** different **minimum and maximum distances** from the LD500 to the leakage are defined to calculate valid leakage loss and costs per year. These distances must be strictly adhered to.

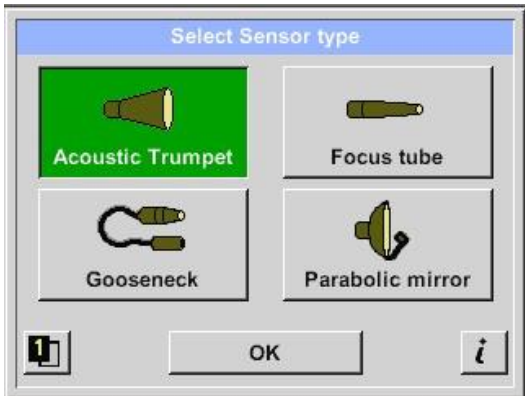

Home → Configuration → Meas.Point

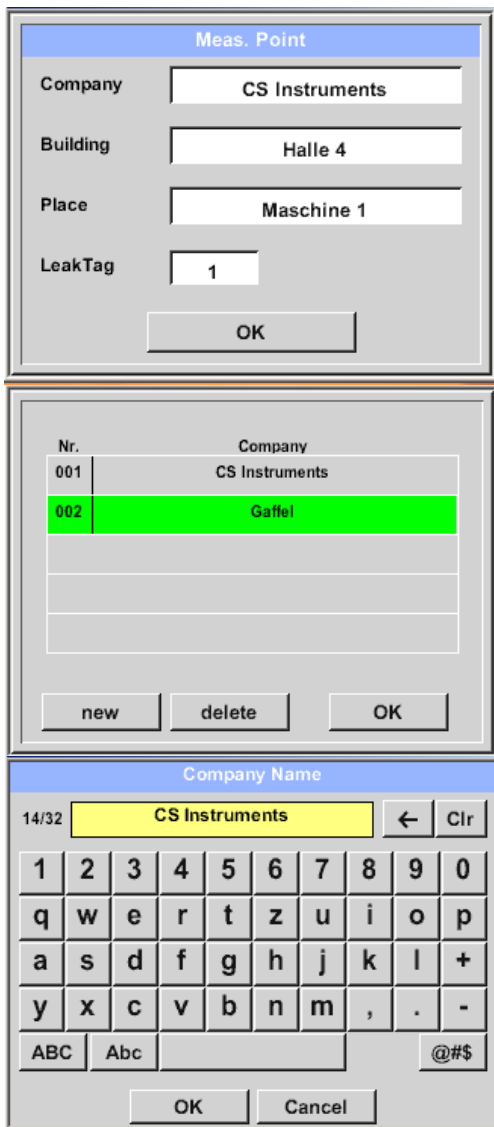

The measuring point is stored for each leakage in its journal data. These can be seen later in the leakage report in the software.

→ LeakTag: will be automatically increased by one after storing a measurement.

All information about the measuring point can be changed by selecting the corresponding text field or the stored measuring points can be loaded from the internal database.

Then a menu opens with the available / saved entries. When selecting a saved value, select it (highlighted in green) and then take over with „OK“.

If a new entry is necessary, the input menu opens after pressing the „new“ button.

Input is accepted via „OK“.

This procedure is analogous to enter the information for company, building and location.

Using the „delete“ button, individual entries can be deleted too.

### 9.3.1.1 Sensortype selection (Measuring tool)

In order to simplify the leak detection for the user, various tools for different measuring conditions have been developed .

The distances mentioned for quantifying the leakage always refer to the front of the respective tool.







If the parabolic mirror / gooseneck has been ordered separatley, the application data for the devices must be loaded into the LD500 first. Data is supplied via USB stick.

**Import:**

Home → Export/Import → Import new Tool → Parabolic Mirror / Gooseneck Serial Number

## Overview and application description of the different sensor types

Acoustic trumpet (standard tool)	Focus tube
 <p>The acoustic trumpet incident ultrasonic waves and thus increases the range of the device. This behavior makes it ideal for medium distances. The leakage can be heard from large distances, but for precise detection the user must approach the leakage and constantly follow the "loudest" point..</p> <p><b>Quantification distance</b> → 1 - 6 m</p> <p><b>Use of acoustic trumpet:</b></p> <ul style="list-style-type: none"> <li>• average distance to pipe/component 0.2 - 6 m</li> <li>• low noise levels</li> <li>• leakage freely accessible</li> <li>• use at distances of up to 6 metres, if no parabolic mirror is available</li> </ul>	 <p>The focus tube allows only very few ultrasonic waves to pass in the direction of the ultrasonic transducer, allowing leakages to be located very precisely. Due to the constriction, use is recommended only for small distances.</p> <p><b>Quantification distance:</b> 0...0,2 m</p> <p><b>Use of focus tube:</b></p> <ul style="list-style-type: none"> <li>• Short distance to pipe/ component 0.05 m</li> <li>• Pipe / component freely accessible</li> <li>• the cpipes and components to be checked are very close to each other</li> <li>• use when no gooseneck available</li> </ul>
Gooseneck	Parabolic mirror
 <p>The gooseneck should be used when the pipes and components to be inspected are very close. In addition, the shape of the gooseneck can be flexibly adapted to inspect hard-to-reach pipes and components. The sensitivity of the gooseneck has been reduced to "suppress" noise. This makes it ideal for targeted, local testing of compressed air components at high noise levels.</p> <p><b>Quantification distance</b> → 0 ...0.05m</p> <p><b>Use of gooseneck:</b></p> <ul style="list-style-type: none"> <li>• small distance to line / component 0.05</li> <li>• leakage not freely accessible</li> <li>• ultrasound interference noise</li> </ul>	 <p>The parabolic mirror bundles horizontally incident ultrasound in its focal point. On the one hand, this leads to a considerable amplification of the measured ultrasound and, on the other hand, to a very precise directional behavior, since ultrasound that does not incident horizontally is reflected away from the reflector. The combination of these two characteristics enables the parabolic reflector to precisely locate leaks at large distances.</p> <p><b>Quantification distance</b> → 3 – 12 m</p> <p><b>Use of parabolic mirror:</b></p> <ul style="list-style-type: none"> <li>• long distance to pipe/component 3 - 12 m</li> <li>• interfering noises</li> <li>• leakage not freely accessible</li> <li>• near leaks (superimposition)</li> </ul>

### 9.3.2 Sensitivity levels

The ultrasonic levels can be understood as a "loudness" of the leakage.

With the "Sensitivity level button" the sensitivity of the LD500 can be adjusted to the environment, which strongly influences the acoustic behaviour of the device and increases or decreases the valid value range.

#### Sensitivity levels

- 0 - 60 dB** Highest sensitivity level of the device (use with small leaks and without noise), selection by "HiSn Button" or "Sensitivity level button".
- 10- 70 dB** Leakage small
- 20 – 80 dB** Leakage medium
- 30 – 90 dB** Leaks large
- 40 – 100 dB** Most insensitive stage (very large leaks, many noises - heavy-duty application)

By default, the LD500 is set to the Auto level and will automatically change levels (10-70 dB to 40-100 dB) depending on the leakage size (ultrasonic level).

The highest sensitivity level 0-60 dB of the unit can be set using the "HiSn" button or the "Sensitivity setting button" and is not part of the Auto function. This mode should be used if the smallest leaks are to be found in a quiet environment.

### 9.3.3 Storing of the measurement

To store the measurements please press either the button „Store“ on the foil keypad, see chapter

[Device components and controls](#) , or by button „Store“  in the display.

All data are stored on to the internal SD card.

The measurement data, the measurement point and the image of the measurement point are saved as a journal, which can be exported later and a report can be created with the CS Leak Reporter (order no.: 0554 0105).

After pressing one of the two „Store“ keys, the corresponding information for the measuring point must be completed. The measuring point information of the last stored storage (company, building and location) is displayed, the numbering of the leaking tag is increased by 1.

e.g .:

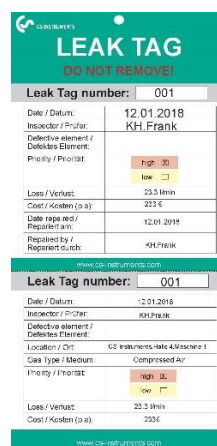
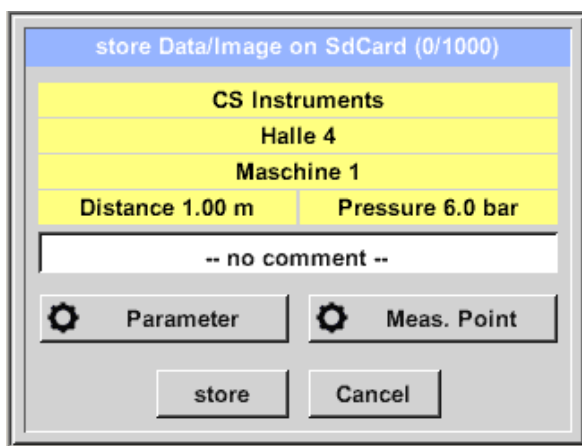

If necessary, fill out the Leak Tag-form and attach it to the measuring location.

Please use correct Leak Tag-number.



### 9.3.3.1 Parameter / Meas. Point (Re-Check)

Store → *Parameter*

Store → *Meas. Point*

At this point, it is again possible to check and correct the parameters „Pressure" and „Distance" and the measuring point.

Changing the parameters gives new values for leakage and cost.

Execution of the corrections see description [chapter 9.3.1](#)

### 9.3.3.2 Comment

Store → Textfield Comment



In addition to the details of the measuring point with company, building and location, it is possible to enter a comment (up to 32 characters).

To do this, select the text field „**Comment**“ and enter the comment.

### 9.3.3.3 Storing measurement data to internal SD-card

Store → store

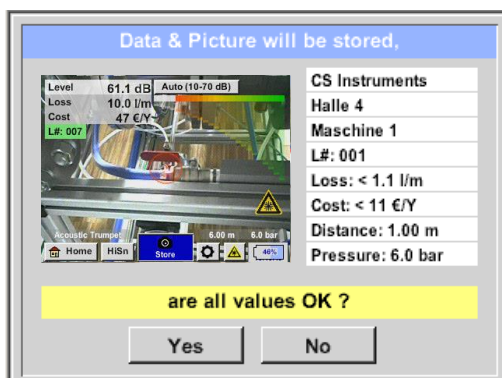

Before final storage of the measurement on the internal SD card, a summary is created and the correctness is queried once more for safety.

Storage is done with the „**Yes**“ key.

The „**No**“ key returns to the previous menu.

## 9.4 Export/Import

With *Export / Import*,

- recorded "journal data" can be transferred to a USB stick
- system settings can be exported as well as imported
- measuring points (company, building and location data) can be exported as well as imported.
- Non-activated optional measurement tools can be activated/loaded.

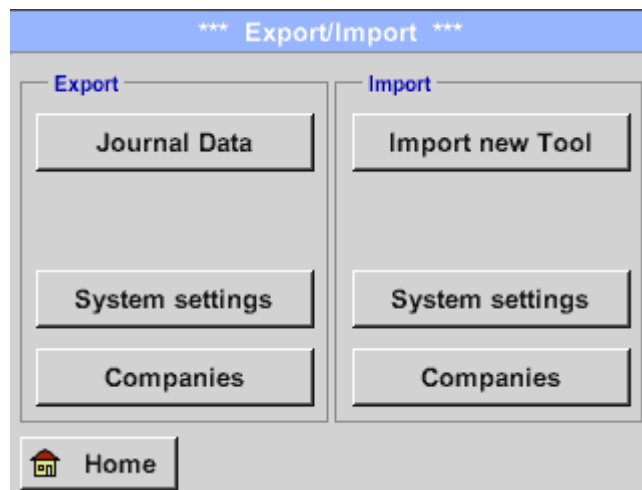



## 9.4.1 Export

### 9.4.1.1 Export „Journal Data“

Export / Import → Export → Journal Data

The screenshots illustrate the workflow for exporting journal data. The first screen shows the main configuration with start and end dates, times, and locations. The second screen shows a calendar where the selected date (1st of February 2018) is highlighted in green. The third screen shows a dialog for selecting specific measurements from the chosen date, with a table listing time, company, building, and measurement place.

Time	Company	Building	Measurement place
10:23	CS Instru...	Halle 4	Maschine 1
10:28	CS Instru...	Halle 4	Maschine 1

With the help of the „**Change**“ -button you can set a period between „**Start**“ and „**End**“.

Stored measurement data that lies within this period will be exported.

The selected date is always highlighted in green and the dates of the Sundays are - as in the calendar - red.

For days on which measurement data was recorded, the date numbers are visually exalted

If several measurements have been recorded on a date, they will appear after the date selection.

Now you can easily select the desired recording.

With „**OK**“. the start or end time is taken over.

Press the „**Export**“ - button to transfer the selected data to the USB stick

In the example given, 3 measurements are exported.

With „**ERASE Journal Data**“ the Journal Database is deleted.

For verification is still a security question.

With „**Back**“ you return to the main menu.

**Attention:** With „**ERASE Journal Data**“ all journal data are deleted.

### 9.4.1.2 Export of System settings

This feature is especially relevant to the version LD 510, here for storing the external sensor settings as well as e.g. display option for charts, sensor value etc.

*Export / Import → Export → System settings*

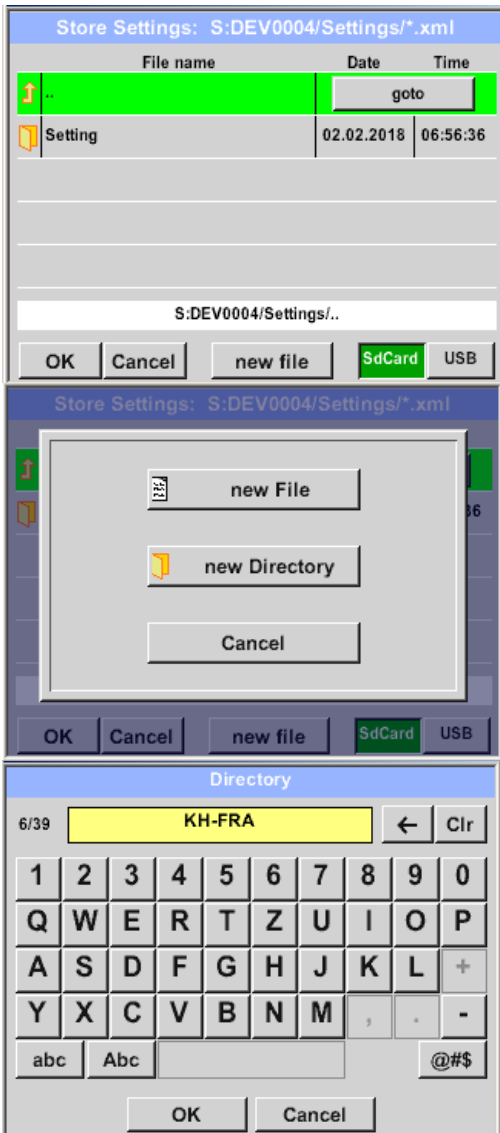

Here the definition of the storage location takes place  
 .Selection for internal SD card with activation of key „**SdCard**“ or on USB stick with key „**USB**“.  
 The selection of the desired folder is made by selecting and activating with „**goto**“ button.

If a new directory is required, this is done by pressing „**new File**“, this can be created by selecting „**new Directory**“

Saving a system file with a new name takes place analogously, then the key „**new File**“ must be pressed

Entries are to be confirmed with „**OK**“.

With „**Cancel**“ you return to the previous menu.

## 9.4.2 Import

### 9.4.2.1 Import of system settings

Export / Import → Import → System settings

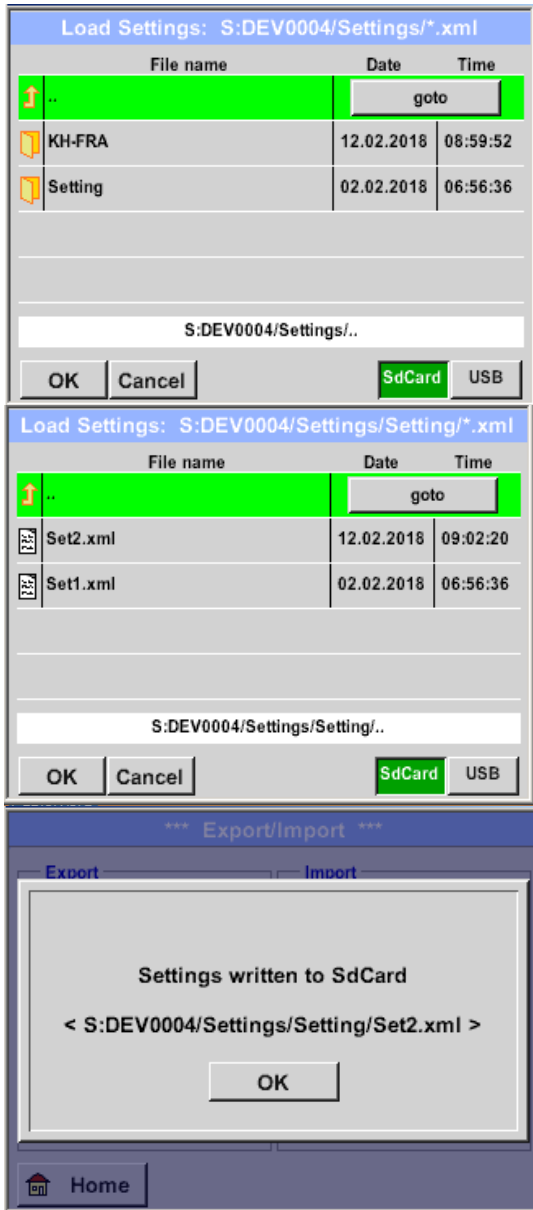

Sequence of directory and file selection is analogous to file export. Selection of internal SD card with activation of key „SdCard“ or on USB stick with key „USB“.

The selection of the desired folder is made by selecting and activating with the „goto“ button, then select corresponding system file.

Selection to be confirmed with „OK“.

Since system-relevant changes are made here, a confirmation prompt is issued, which must be confirmed with „OK“.

### 9.4.2.2 Import new measurement tool

Export / Import → Import → Import new Tool

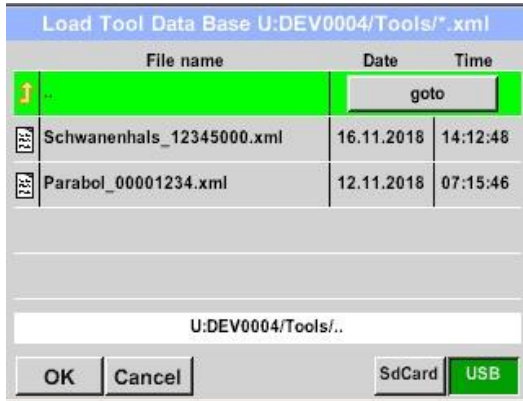

The directory and file selection process is the same as for export e.g. system settings  
 Selection of internal SD card with activation of button "**SdCard**" or of USB stick with button "**USB**".

Select the desired folder by pressing the "**goto**" key and then the corresponding system file.

Confirm your entries witht „**OK**“.

Since system relevant changes are made here, a security query is made which must be confirmed with "**Yes**".

### 9.4.3 Export / Import Customer database

These functions allow the stored measuring point descriptions (companies, buildings and location) to be exported as an XML file or to be imported from another LD 500 exported database.

That means it is also possible to create and import the database externally, but the prerequisite is the correct format of the XML file.

*Export / Import → Export → Customers*

*Export / Import → Import → Customers*

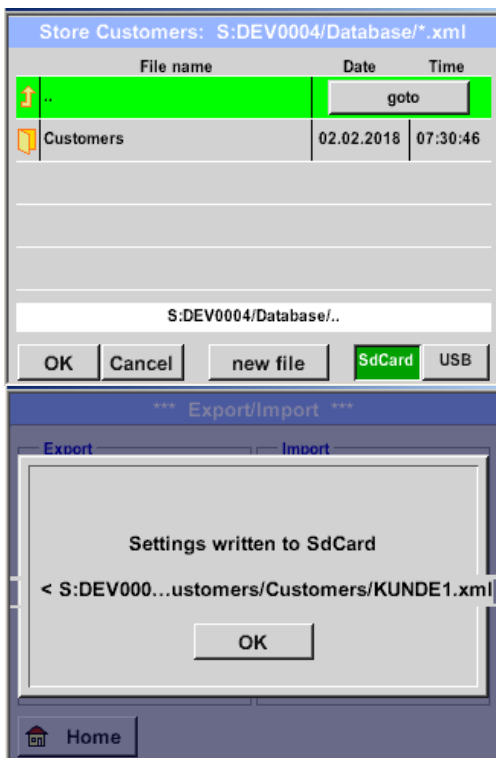

As data changes are made during importing, a confirmation question needs to be confirmed with "„Yes“".

**Remark:** Customer data will be exported to folder \\DEV0004/Database .  
Data to be imported (XML files) must be stored in the directory \\DEV0004/Database as well.

## 9.5 View bitmaps

View Bitmaps → Select Screenshot



This allows the stored pictures (measurement pictures) on the SD-Card or USB Stick to load and shown in the display again.

Please press button „Select Screenshot“ and select the required picture (bitmap).

The pictures are stored and organized in different directories

The directory structure is year / calendar week

Designation: BMyyCWxx

yy = Year xx = calendar week

The selection of the desired folder is made by selecting and activating with the „goto“ button.

Select the desired image and then display with „OK“.

## 9.6 Device Settings

The settings are all protected by a password!

Settings or changes are generally confirmed with **OK!**

### Remark:

If you go back to main menu and then again one of the setting menus is called, you must enter the password again.



Overview of the *Settings*

### 9.6.1 Passwort-Einstellung

Settings → Password Settings

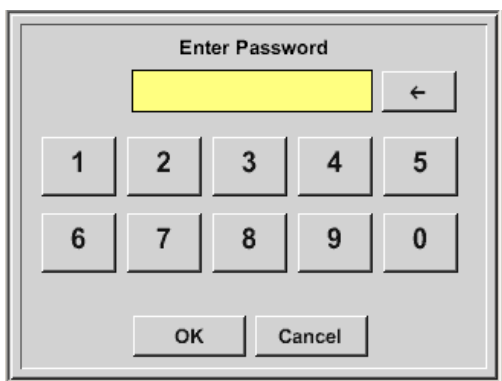

Factory settings for password at the time of delivery: 0000 (4 times zero).

If required, the password can be changed in the *Password settings*.

The new password must be entered two times in a row and in each case confirmed with **OK**

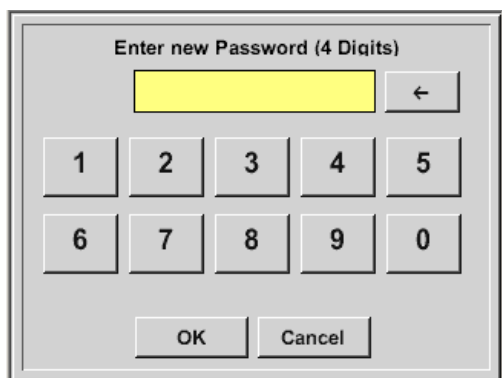

If an incorrect password is entered there appears *Enter password* or *New password repeat* in red font.

If you can't remember the password, please use Master password in order to enter a new password.

### Remark:

The master password is supplied together with the instrument's documentation.

## 9.6.2 Device Settings

Settings → Device settings

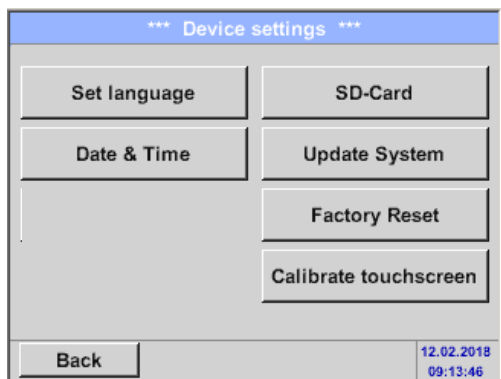

Overview of *Device settings*

### 9.6.2.1 Language

Settings → Device settings → Set language

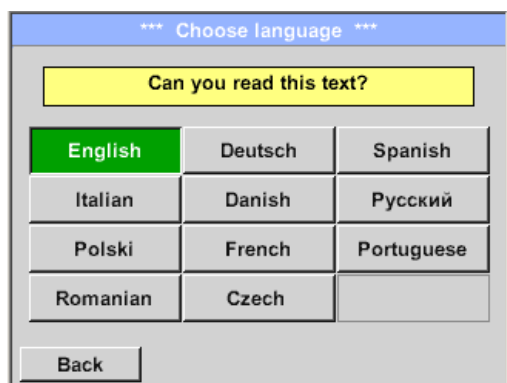

Here you can select one of 11 languages for the LD 500.



### 9.6.2.2 Date & Time

Settings → Device settings → Date & Time

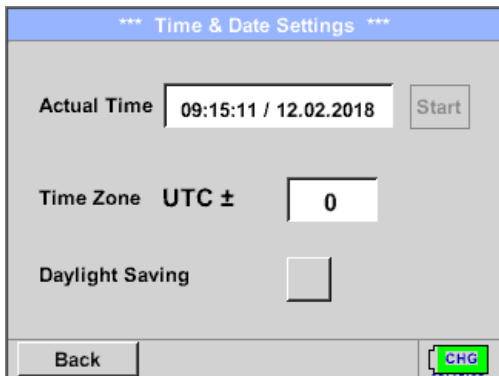

By pushing the *Time Zone* description field and enter the correct *UTC*, you can set the correct time all over the world.

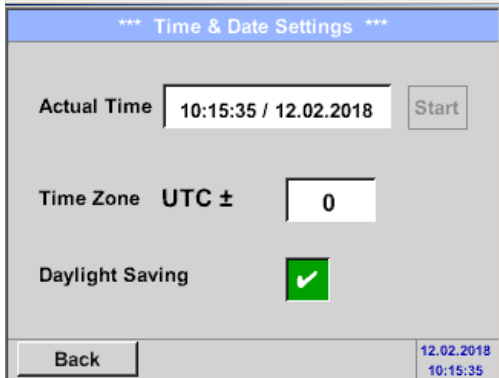

The summer and wintertime switchover is realized by pushing the *Daylight Saving* button.

### 9.6.2.3 SD-Card

Settings → Device settings → SD-Card → Reset Logger Database

Settings → Device settings → SD-Card → Erase SdCard

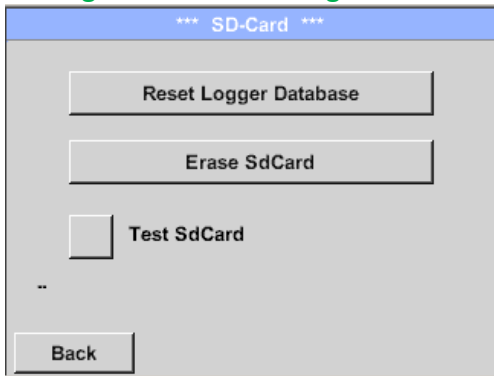

By pressing *Reset Logger Database* all actual stored data on SD-Card will be blocked for use in LD500 / LD510. Nevertheless all data are still stored and available for external use only.

By pressing *Erase SdCard* all Data on the SD-Card will be deleted.

Settings → Device settings → SD-Card → Test SdCard

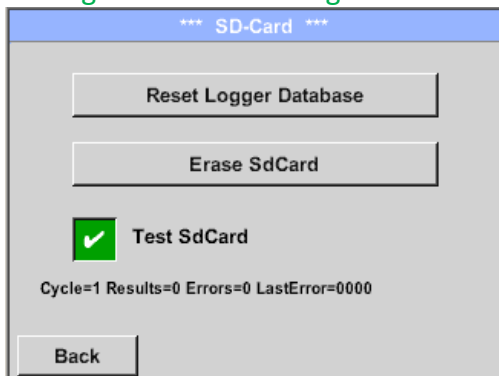

With activation of *Test SdCard* data are written and read to and from the SD-card.

The number of test cycles, as well as possible errors and error codes are display in the status line.

Press the *Back* button to returns to the device settings menu.

### 9.6.2.4 System update

If required, there is the possibility for the LD 500 to download a firmware update to the device via the USB stick. The latest software is available on the CS Instruments GmbH homepage

The received file must then be stored on the USB stick and transferred to your device as described below.

Settings → Device settings → System-Update

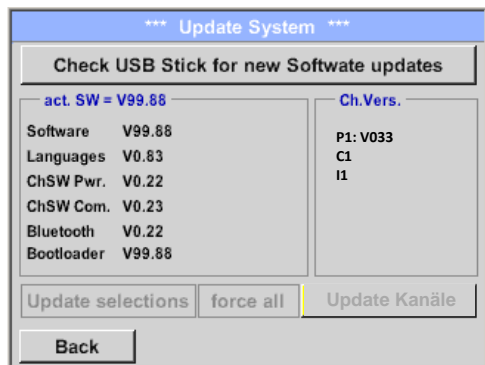

Overview of *System-Update*-Functions.

#### 9.6.2.4.1 Check for Updates

Settings → Device settings → System-Update → check USB-Stick for new Updates

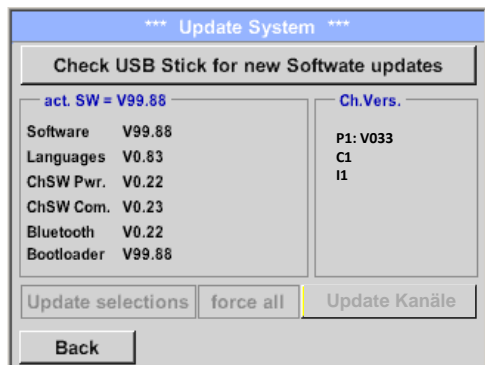

If after pressing the button *“Check USB Stick for new Software updates”* the following messages appear in the window, the LD 500 is not properly connected to the USB flash drive or there are no files available.

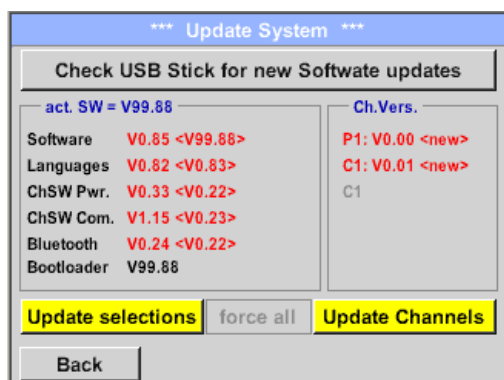

If the LD 500 is correctly connected to the USB stick and there are new versions of the individual SW Parts, the new versions are marked in red.

The update is started by pressing the *“Update selections”* button.

If it is required to install an older software version, you have press the button *„Force all“*

### 9.6.2.4.2 Update Channels

Settings → Device settings → System-Update → Update-Channels

If there is an update either for the internal and external channel (LD 510 only), it must be started separately

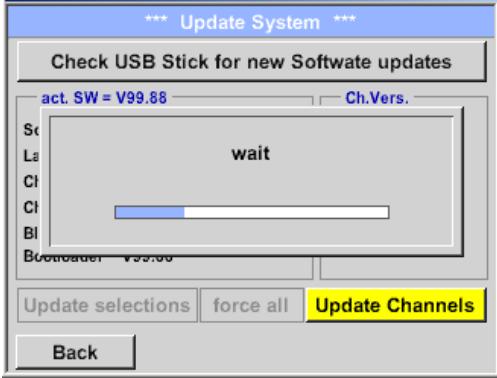

Update for Channels LD 500/ 510.

**Important:**

If the *Reboot system* button appears after the update, it must be pushed to restart the LD 500!

### 9.6.2.5 Factory Reset

#### 9.6.2.5.1 Reset to default settings

Settings → Device settings → System → Reset to Defaults

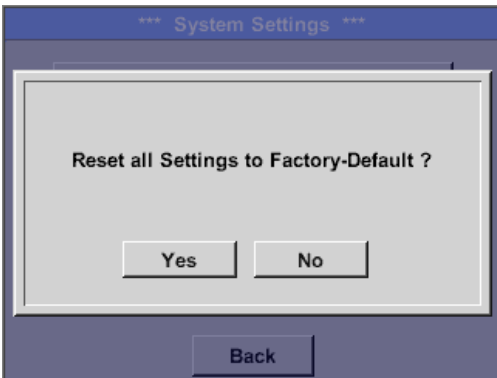

Bevor the settings are changed to the production default settings a safety prompt is displayed and must be confirmed by pressing the button „Yes“.

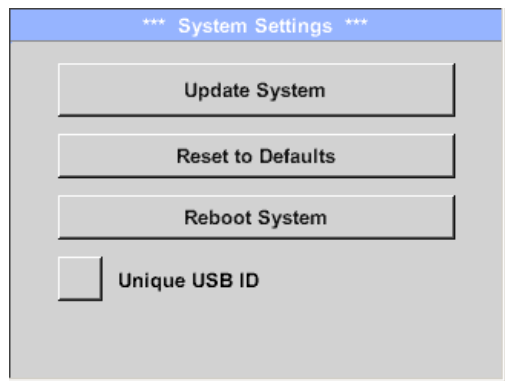

If needed with „**Reboot System**“ the LD 500 could be started(reboot) here.

#### 9.6.2.5.2 Unique USB ID

For connections with the PC, a status and therefore a unique USB ID can be defined here. Relevant for simultaneous connection of several USB devices to the PC.

### 9.6.2.6 Calibration of touchpanel

Settings → Device settings → calibrate touchscreen

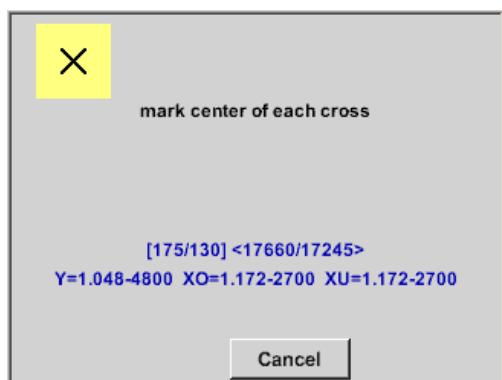
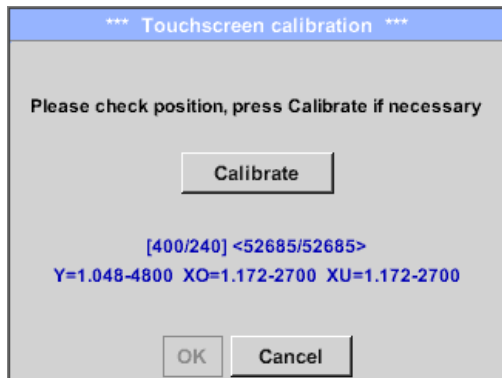

If necessary, the touch-screen calibration can be changed here.

Push *Calibrate* and it appears, 1. left above, 2. bottom right, 3. bottom left, 4. right above and 5. in the middle, a calibration cross that must be pushed consecutively.

If the calibration finished positive a message "*Calibration successful*" appears and have to be confirmed with *OK*.

Is this not the case, so you can repeat the calibration with the help of the *Cancel* and *Calibrate* buttons.

### 9.6.3 Set backlight brightness

Settings → Set backlight

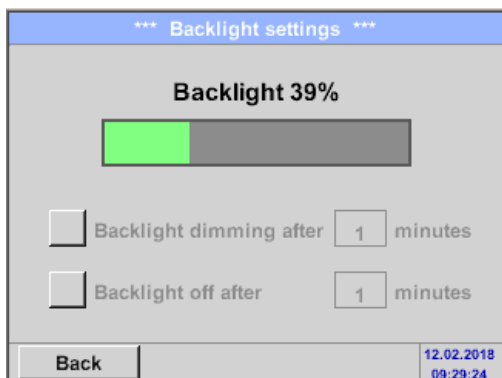

Here you adjust the desired *Backlight* (15-100%) of the display directly.

E.g. *Backlight* to 39 %

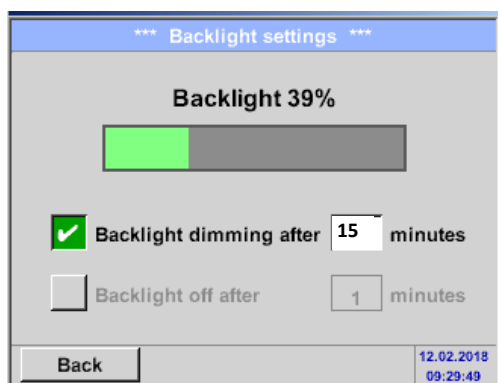

With the help of the *Backlight dimming after* button, after a definable time interval (here after 15 minutes), the *Backlight* can be reduced to the minimum.

As soon as the dimmed screen is operated again, the *Backlight* is committed automatically on the last set value before dimming.

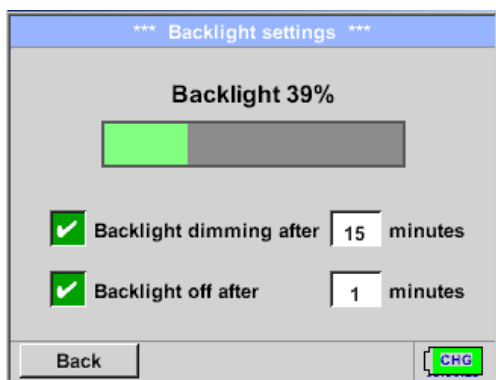

To reduce the energy consumption (device runtime), you can switch off the display backlight by setting "*Backlight off after*".

**Remark:**

At the first touch, the *Backlight* in our example is reset to 39%, after that a "normal" function operation is possible.

**Important:**

If the *Backlight dimming after* button is not activated, then the *Backlight* stays permanently on, in the currently set brightness.

## 9.6.4 Cleaning

Settings → Cleaning



This function can be used for cleaning the touch panel during running measurements.

If one minute is not enough time to clean, the process can be repeated at any time.

Is the cleaning faster finished, then you can push the *to abort press long* button (for one or two seconds) to cancel.

## 9.6.5 System-Status

E Settings → System-Status

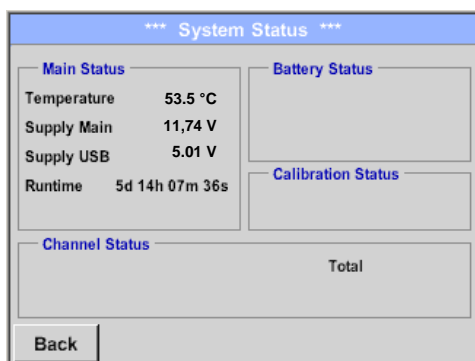

The menu item **“System status”** provides information about the power supply voltages and an operating hour counter.

## 9.6.6 About LD 500

Settings → about LD 500

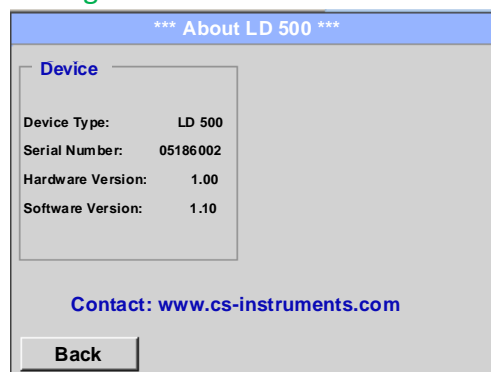

Brief description of the **Hardware** and **Software Version**, as well as the **Serial Number** of the LD 500.

Under options, you can buy four additional, different functions, if you have not done this by ordering.

## 10 Charging the batteries

The battery is charged within the device. For this, the supplied plug-in power supply is connected to the built-in charging socket of the LD 500 and the 230V socket.



The LD 500 checks the charging status of the battery and starts the charging process automatically if necessary.

To protect the Li-ION accumulator of exhaustive discharge the device is switching off automatically if a cell voltage of 6,4V will be reached.

## 11 D 510

### 11.1 Selection External sensor

The use of an „*external Sensor*“ requires to switch to its mode.

Home → Mode → Externer Sensor



Home menu for external sensor connection





### 11.2 Input signals of ext. sensor LD510

Input signals		
Current signal (0 – 20 mA / 4 – 20 mA) internal or external power supply	Measuring range	0 – 20 mA / 4 – 20 mA
	Resolution	0,0001 mA
	Accuracy	$\pm 0,03 \text{ mA} \pm 0,05 \%$
	Input resistance	50 $\Omega$
Voltage signal (0 - 1V)	Measuring range	0 - 1 V
	Resolution	0,05 mV
	Accuracy	$\pm 0,2 \text{ mV} \pm 0,05 \%$
	Input resistance	100 k $\Omega$
Voltage signal (0 - 10 V / 30 V)	Measuring range	0 - 10 V/30 V
	Resolution	0,5 mV
	Accuracy	$\pm 2 \text{ mV} \pm 0,05 \%$
	Input resistance	1 M $\Omega$
RTD Pt100	Measuring range	-200 - 850 °C
	Resolution	0,1 °C
	Accuracy	$\pm 0,2 \text{ °C}$ at -100 - 400 °C $\pm 0,3 \text{ °C}$ (further range)
RTD Pt1000	Measuring range	-200 - 850 °C
	Resolution	0,1 °C
	Accuracy	$\pm 0,2 \text{ °C}$ at -100 - 400 °C $\pm 0,3 \text{ °C}$ ( further range )
Pulse	Measuring range	minimal pulse length 100 $\mu\text{s}$ frequency 0 - 1 kHz max. 30 VDC

### 11.3 Cable cross section

#### 11.3.1 Sensor circuit points/Output signal:

AWG26, cable cross-sections: 0.14 mm<sup>2</sup>

**11.4 Connection diagrams for different sensor types**

**11.4.1 Connector pin assignment for all sensors at PI 500**

The interface connector to be used is a ODU Medi Snap 8 pin – Reference: K11M07-P08LFD0-6550

Available connection cables at CS-Instruments are:

ODU with Open ends: Order no 0553 0501, cable length: 5 m.  
 Order no 0553 0502, cable length: 10 m.

ODU with M12 Connector: Order no 0553 0503, cable length: 5 m.

Extension cable (ODU/ODU): Order no 0553 0504, cable length: 10 m.

**Connection scheme:**

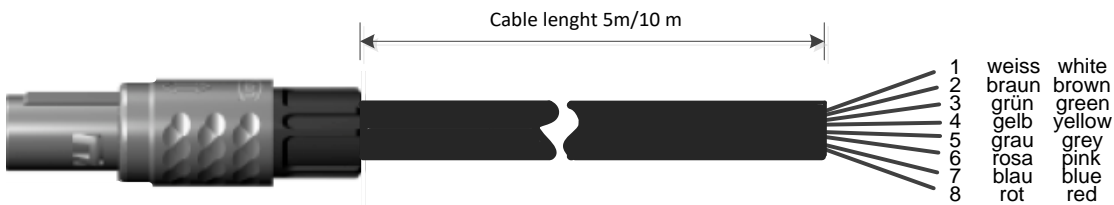
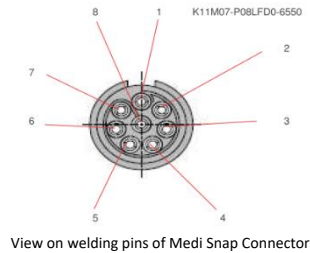
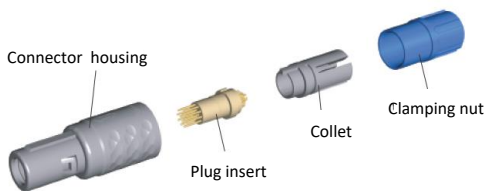

<table border="1"> <tr> <td>+ RS485</td> <td>● 1</td> <td>White</td> </tr> <tr> <td>- RS485</td> <td>● 2</td> <td>Brown</td> </tr> <tr> <td>SDI</td> <td>● 3</td> <td>Green</td> </tr> <tr> <td>Analog IN +</td> <td>● 4</td> <td>Yellow</td> </tr> <tr> <td>Analog IN -</td> <td>● 5</td> <td>Grey</td> </tr> <tr> <td>I (500µA)</td> <td>● 6</td> <td>Pink</td> </tr> <tr> <td>+VB 24Vdc</td> <td>● 7</td> <td>Blue</td> </tr> <tr> <td>-VB GND</td> <td>● 8</td> <td></td> </tr> </table>	+ RS485	● 1	White	- RS485	● 2	Brown	SDI	● 3	Green	Analog IN +	● 4	Yellow	Analog IN -	● 5	Grey	I (500µA)	● 6	Pink	+VB 24Vdc	● 7	Blue	-VB GND	● 8		<p><b>+ RS485</b></p> <p><b>- RS485</b></p> <p><b>SDI</b> (CS-internal data transmission for all Dew point and Flow sensor FA/ VA 400)</p> <p><b>ANALOG IN +</b></p> <p><b>ANALOG IN -</b></p> <p><b>STROMQUELLE 500 µA</b></p> <p><b>+VB, 24V DC Power supply for sensor</b></p> <p><b>-VB, GND Sensor</b></p>
+ RS485	● 1	White																							
- RS485	● 2	Brown																							
SDI	● 3	Green																							
Analog IN +	● 4	Yellow																							
Analog IN -	● 5	Grey																							
I (500µA)	● 6	Pink																							
+VB 24Vdc	● 7	Blue																							
-VB GND	● 8																								

### 11.4.2 Connection for CS dew point- and consumption sensors, series FA/VA 5xx

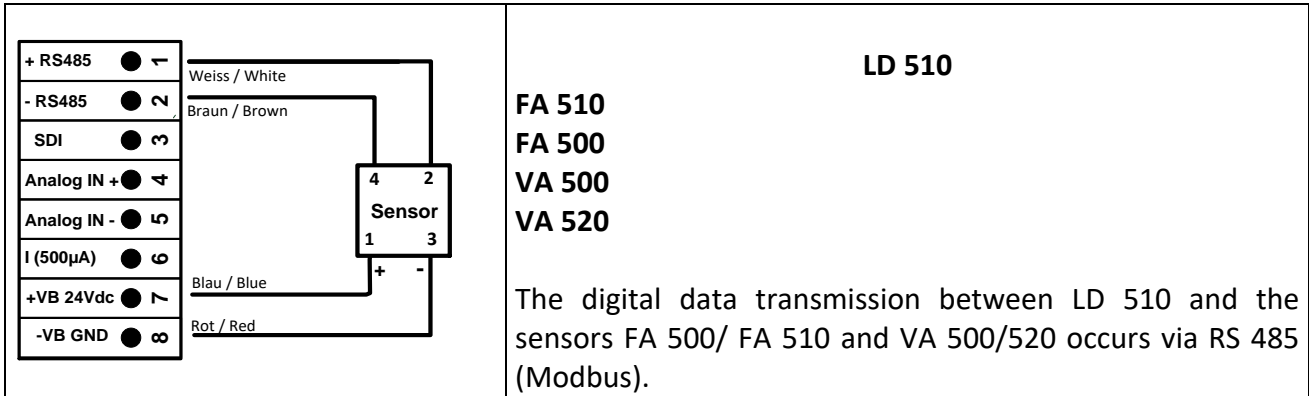

### 11.4.3 Connection with RS485

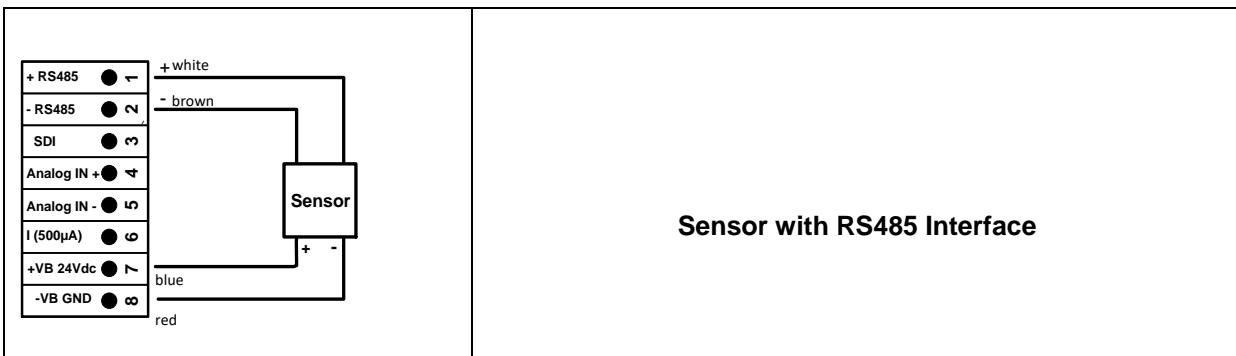

### 11.4.4 Three- and four-wire power supply 0 - 1/10/30 VDC

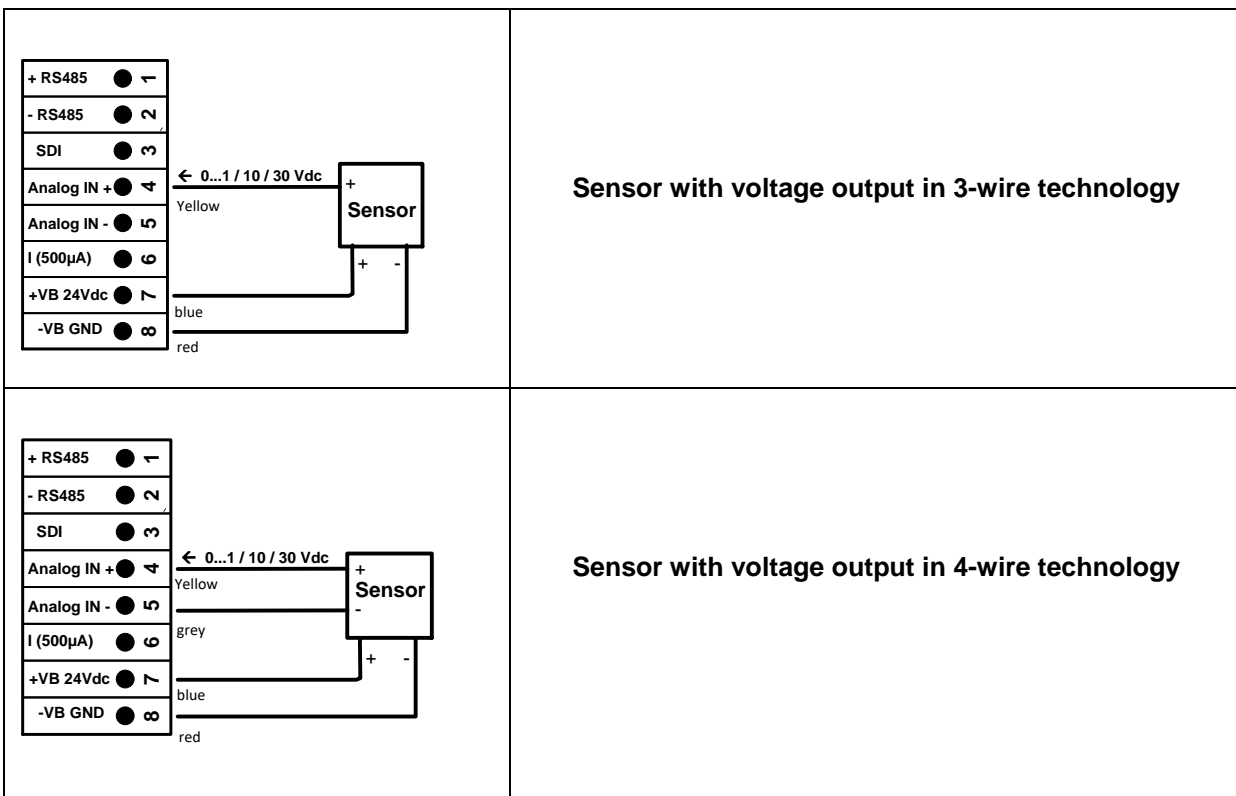

### 11.4.5 Analogue two-, three-, and four-wire current signal

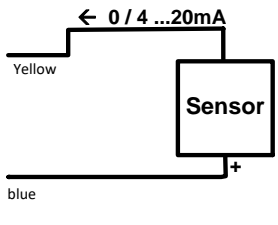
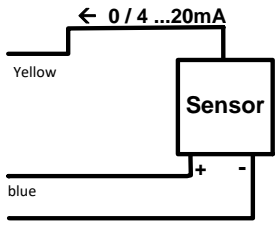
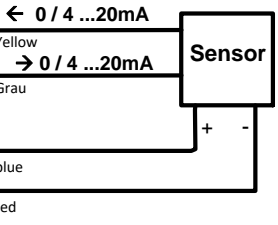
Sensors with 4 - 20 mA-output in 2-wire technology																									
<table border="1" style="display: inline-table; vertical-align: top;"> <tr><td>+ RS485</td><td>●</td><td>1</td></tr> <tr><td>- RS485</td><td>●</td><td>2</td></tr> <tr><td>SDI</td><td>●</td><td>3</td></tr> <tr><td>Analog IN +</td><td>●</td><td>4</td></tr> <tr><td>Analog IN -</td><td>●</td><td>5</td></tr> <tr><td>I (500µA)</td><td>●</td><td>6</td></tr> <tr><td>+VB 24Vdc</td><td>●</td><td>7</td></tr> <tr><td>-VB GND</td><td>●</td><td>8</td></tr> </table> 	+ RS485	●	1	- RS485	●	2	SDI	●	3	Analog IN +	●	4	Analog IN -	●	5	I (500µA)	●	6	+VB 24Vdc	●	7	-VB GND	●	8	<p><b>LD 510</b></p>
+ RS485	●	1																							
- RS485	●	2																							
SDI	●	3																							
Analog IN +	●	4																							
Analog IN -	●	5																							
I (500µA)	●	6																							
+VB 24Vdc	●	7																							
-VB GND	●	8																							
Sensors with 4 - 20 mA output in 3-wire technology																									
<table border="1" style="display: inline-table; vertical-align: top;"> <tr><td>+ RS485</td><td>●</td><td>1</td></tr> <tr><td>- RS485</td><td>●</td><td>2</td></tr> <tr><td>SDI</td><td>●</td><td>3</td></tr> <tr><td>Analog IN +</td><td>●</td><td>4</td></tr> <tr><td>Analog IN -</td><td>●</td><td>5</td></tr> <tr><td>I (500µA)</td><td>●</td><td>6</td></tr> <tr><td>+VB 24Vdc</td><td>●</td><td>7</td></tr> <tr><td>-VB GND</td><td>●</td><td>8</td></tr> </table> 	+ RS485	●	1	- RS485	●	2	SDI	●	3	Analog IN +	●	4	Analog IN -	●	5	I (500µA)	●	6	+VB 24Vdc	●	7	-VB GND	●	8	<p><b>LD 510</b></p>
+ RS485	●	1																							
- RS485	●	2																							
SDI	●	3																							
Analog IN +	●	4																							
Analog IN -	●	5																							
I (500µA)	●	6																							
+VB 24Vdc	●	7																							
-VB GND	●	8																							
Sensors with 4 - 20 mA output in 4-wire technology																									
<table border="1" style="display: inline-table; vertical-align: top;"> <tr><td>+ RS485</td><td>●</td><td>1</td></tr> <tr><td>- RS485</td><td>●</td><td>2</td></tr> <tr><td>SDI</td><td>●</td><td>3</td></tr> <tr><td>Analog IN +</td><td>●</td><td>4</td></tr> <tr><td>Analog IN -</td><td>●</td><td>5</td></tr> <tr><td>I (500µA)</td><td>●</td><td>6</td></tr> <tr><td>+VB 24Vdc</td><td>●</td><td>7</td></tr> <tr><td>-VB GND</td><td>●</td><td>8</td></tr> </table> 	+ RS485	●	1	- RS485	●	2	SDI	●	3	Analog IN +	●	4	Analog IN -	●	5	I (500µA)	●	6	+VB 24Vdc	●	7	-VB GND	●	8	<p><b>LD 510</b></p>
+ RS485	●	1																							
- RS485	●	2																							
SDI	●	3																							
Analog IN +	●	4																							
Analog IN -	●	5																							
I (500µA)	●	6																							
+VB 24Vdc	●	7																							
-VB GND	●	8																							

11.4.6 Two-, three- and four-wire connector pin assignments for PT100/PT1000/KTY81

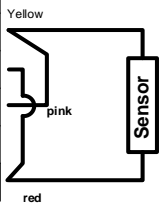
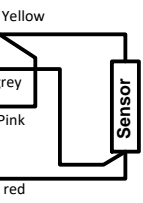
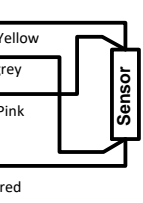
<table border="1" style="display: inline-table; vertical-align: top;"> <tr><td>+ RS485</td><td>●</td><td>1</td></tr> <tr><td>- RS485</td><td>●</td><td>2</td></tr> <tr><td>SDI</td><td>●</td><td>3</td></tr> <tr><td>Analog IN +</td><td>●</td><td>4</td></tr> <tr><td>Analog IN -</td><td>●</td><td>5</td></tr> <tr><td>I (500µA)</td><td>●</td><td>6</td></tr> <tr><td>+VB 24Vdc</td><td>●</td><td>7</td></tr> <tr><td>-VB GND</td><td>●</td><td>8</td></tr> </table> 	+ RS485	●	1	- RS485	●	2	SDI	●	3	Analog IN +	●	4	Analog IN -	●	5	I (500µA)	●	6	+VB 24Vdc	●	7	-VB GND	●	8	<p>2-wire PT100/PT1000/KTY81</p>
+ RS485	●	1																							
- RS485	●	2																							
SDI	●	3																							
Analog IN +	●	4																							
Analog IN -	●	5																							
I (500µA)	●	6																							
+VB 24Vdc	●	7																							
-VB GND	●	8																							
<table border="1" style="display: inline-table; vertical-align: top;"> <tr><td>+ RS485</td><td>●</td><td>1</td></tr> <tr><td>- RS485</td><td>●</td><td>2</td></tr> <tr><td>SDI</td><td>●</td><td>3</td></tr> <tr><td>Analog IN +</td><td>●</td><td>4</td></tr> <tr><td>Analog IN -</td><td>●</td><td>5</td></tr> <tr><td>I (500µA)</td><td>●</td><td>6</td></tr> <tr><td>+VB 24Vdc</td><td>●</td><td>7</td></tr> <tr><td>-VB GND</td><td>●</td><td>8</td></tr> </table> 	+ RS485	●	1	- RS485	●	2	SDI	●	3	Analog IN +	●	4	Analog IN -	●	5	I (500µA)	●	6	+VB 24Vdc	●	7	-VB GND	●	8	<p>3-wire PT100/PT1000/KTY81</p>
+ RS485	●	1																							
- RS485	●	2																							
SDI	●	3																							
Analog IN +	●	4																							
Analog IN -	●	5																							
I (500µA)	●	6																							
+VB 24Vdc	●	7																							
-VB GND	●	8																							
<table border="1" style="display: inline-table; vertical-align: top;"> <tr><td>+ RS485</td><td>●</td><td>1</td></tr> <tr><td>- RS485</td><td>●</td><td>2</td></tr> <tr><td>SDI</td><td>●</td><td>3</td></tr> <tr><td>Analog IN +</td><td>●</td><td>4</td></tr> <tr><td>Analog IN -</td><td>●</td><td>5</td></tr> <tr><td>I (500µA)</td><td>●</td><td>6</td></tr> <tr><td>+VB 24Vdc</td><td>●</td><td>7</td></tr> <tr><td>-VB GND</td><td>●</td><td>8</td></tr> </table> 	+ RS485	●	1	- RS485	●	2	SDI	●	3	Analog IN +	●	4	Analog IN -	●	5	I (500µA)	●	6	+VB 24Vdc	●	7	-VB GND	●	8	<p>4-wire PT100/1000/KTY81</p>
+ RS485	●	1																							
- RS485	●	2																							
SDI	●	3																							
Analog IN +	●	4																							
Analog IN -	●	5																							
I (500µA)	●	6																							
+VB 24Vdc	●	7																							
-VB GND	●	8																							

### 11.5 Dew Point Sensor FA 500 / FA 510 (RS 485 Modbus)

**First step:** choose an unused sensor digital channel

External sensor → Settings → Sensor settings → C1

**Second step:** choose type FA 5xx

External sensor → Settings → Sensor settings → C1 → Type description field → FA 5xx

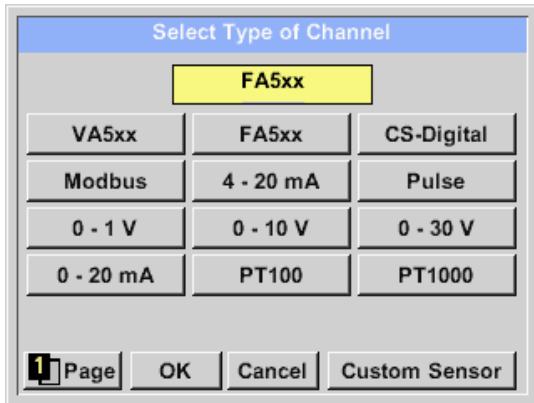

Now the *Type FA 5xx* is to be selected for the FA 5xx series and confirmed by pressing the *OK* button.

External sensor → Settings → Sensor settings → C1 → text field "Name"

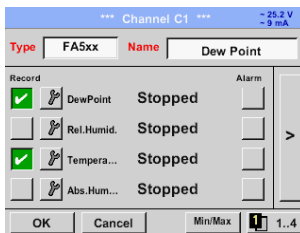

For input of a name, please enter the text field „*Name*“.

It is possible to enter a name with max. 24 characters.

Confirmation by pressing the *OK*-button.

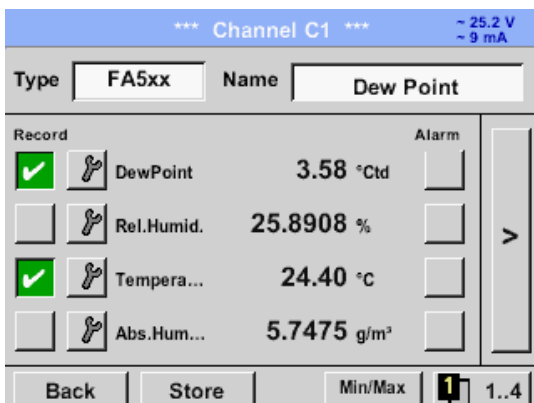
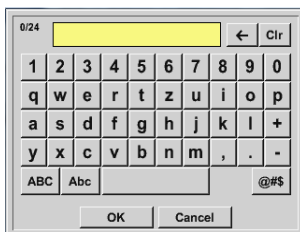

The connection with the FA 5xx sensor is done after confirmation by pressing *“OK”*.

## 11.5.1 Settings Dew point sensor FA 500 / FA 510

### 11.5.1.1 Unit selection for temperature and humidity

External sensor → Settings → Sensor settings → C1 → arrow right (2.page)

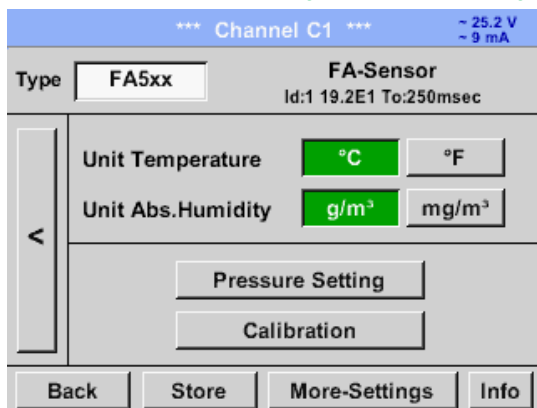

\*\*\* Channel C1 \*\*\* ~ 25.2 V  
~ 9 mA

Type **FA5xx** FA-Sensor  
Id:1 19.2E1 To:250msec

Unit Temperature **°C** °F

Unit Abs. Humidity **g/m³** mg/m³

Pressure Setting

Calibration

Back Store More-Settings Info

Unit selection for temperature and humidity by pressing the button °C, °F, g/m<sup>3</sup> or mg/m<sup>3</sup>.

Confirm the settings by pressing the **OK** button.

### 11.5.1.2 Definition of the System pressure (relative pressure value)

External sensor → Settings → Sensor settings → C1 → arrow right (2.page) → Pressure Setting

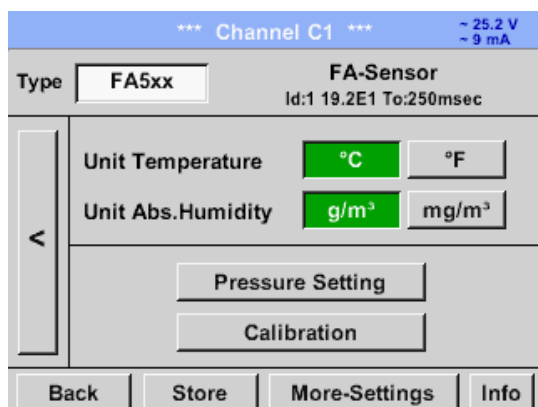

\*\*\* Channel C1 \*\*\* ~ 25.2 V  
~ 9 mA

Type **FA5xx** FA-Sensor  
Id:1 19.2E1 To:250msec

Unit Temperature **°C** °F

Unit Abs. Humidity **g/m³** mg/m³

Pressure Setting

Calibration

Back Store More-Settings Info

The system pressure is inserted by entering the values in the corresponding text field. The unit can be freely selected, selection menu is opened by pressing the corresponding button units

Confirm the settings by pressing the **OK** button.

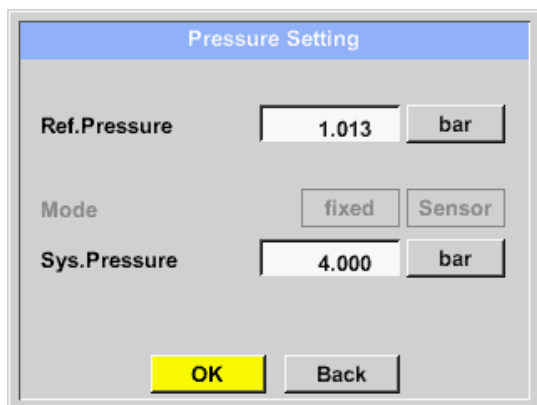

Pressure Setting

Ref. Pressure 1.013 bar

Mode fixed Sensor

Sys. Pressure 4.000 bar

OK Back

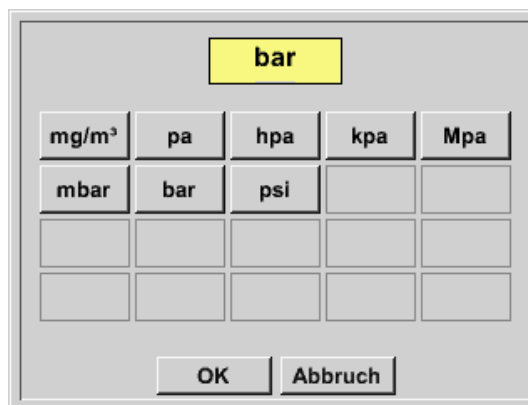

bar

mg/m³ pa hpa kpa Mpa

mbar bar psi

OK Abbruch

### 11.5.1.3 Definition of Reference pressure (absolute pressure value)

External sensor → Settings → Sensor settings → C1 → arrow right (2.page) → Pressure Setting → Text field Ref.Pressure

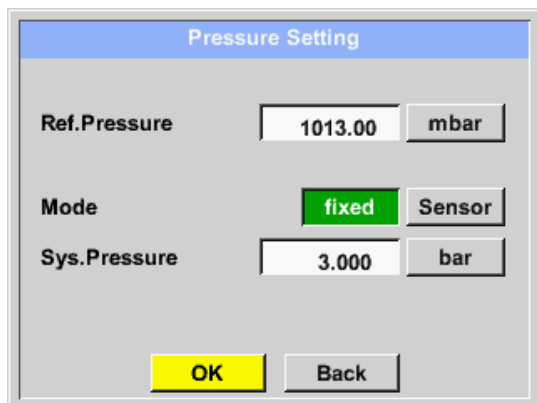

Reference pressure is the pressure for that the dew point in relaxation will be back-calculated.

Default- Value is 1013 mbar (Atm. Pressure).

Confirm the settings by pressing the **OK** button.

### 11.5.1.4 Calibration

External sensor → Settings → Sensor settings → C1 → arrow right (2.page) → Calibration

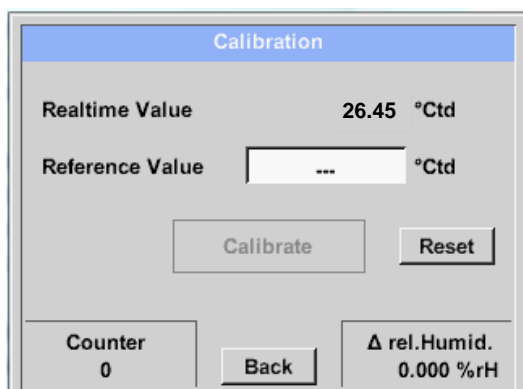

Here, a one-point calibration can be performed.

For that purpose, please enter in the text box **"Reference Value"** the new correct dew point value.

Then by pressing the "Calibration" button taking over the inserted reference value.

Calibration can be put back to factory setting by pressing **„Reset“**.

For each performed calibration, the counter is increased by 1.

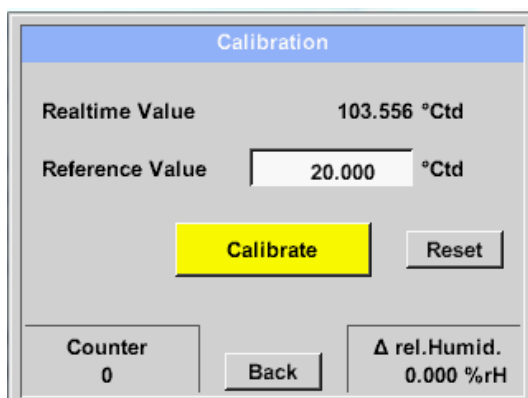



### 11.5.1.5 More Settings Analogue output 4-20mA

External sensor → Settings → Sensor settings → C1 → arrow right (2.page) → More-Settings → 4-20mA

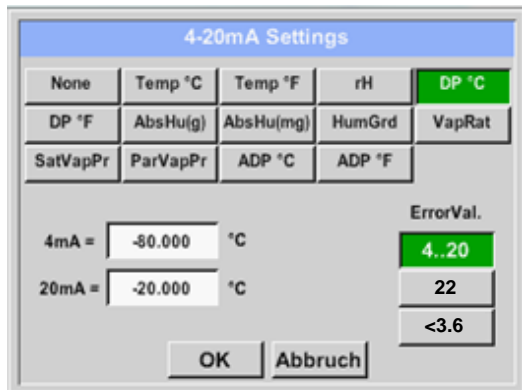

This menu allows the adjustment / assignment of the measurement value and the scaling of the analogue output.

Selection of the measurement value by selecting the appropriate measured value key in this example, "*DP °C*" for dew point °Ctd.

In text fields "*4mA*" and "*20mA*" the appropriate scaling values are entered, here from -80° Ctd (4mA) to -20° Ctd (20mA).

With "*Error Val*" is determined what is the output in case of error at the analog output.

- <3.6 Sensor error / System error
- 22 Sensor error / System error
- 4..20 Output according Namur (3.8mA – 20.5 mA)  
< 4mA to 3.8 mA Measuring range under range  
>20mA to 20.5 mA Measuring range exceeding

**11.6 Flow sensor of type VA 500 / VA 520 / VA 550 / VA 570 (RS 485 Modbus)**

**First step:** choose an unused sensor digital channel

External sensor → Settings → Sensor settings → C1

**Second step:** choose type VA 5xx

External sensor → Settings → Sensor settings → C1 → Type description field → VA 5xx

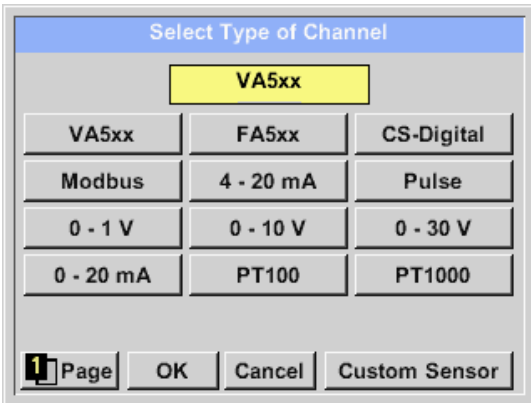

Now the *Type VA 5xx* is selected for the VA 5xx series and confirmed by pressing the *OK* button.

External sensor → Settings → Sensor settings → C1 → Name description field

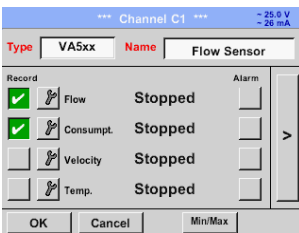

Input of a name, please enter the text field „*Name*“.

It is possible to enter a name with max. 24 characters.

Confirmation by pressing the *OK*-button.

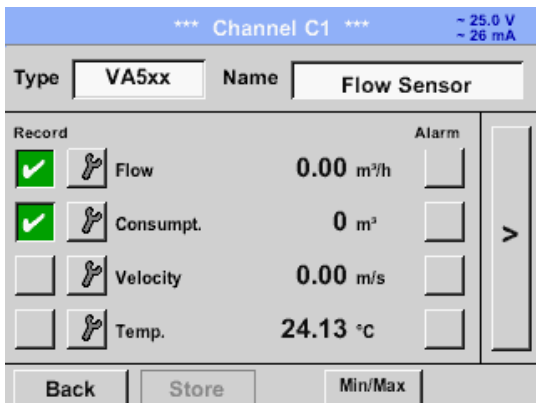
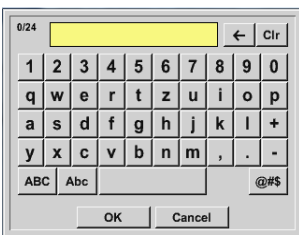

The connection with the VA 5xx sensor is done after confirmation by pressing “*OK*”.

### 11.6.1 Settings for Flow sensor VA 5xx

External sensor → Settings → Sensor settings → C1 → arrow right (2.page)

For each text field could be the either a value or a unit be set.

Settings by entering the text field and then input a value or select the unit for the appropriate field.

In case of VA 520 and VA 570 with integrated measuring section the diameter and diameter unit field are not accessible.

#### 11.6.1.1 Diameter settings (only for VA 500 or VA 550)

External sensor → Settings → Sensor settings → C1 → arrow right (2.page) → diameter description field

External sensor → Settings → Sensor settings → C1 → arrow right (2.page) → diameter unit description field

**Important:**

Only for VA 500 or VA 550 possible to change the *inner diameter*

Here the “*inner diameter*” is set to 27.5mm.

Please confirm by pressing the *OK* button and go back with *arrow left (1.page)*.

After pressing the *Unit* Text fields following units are selectable.

**Important:**

The *inner diameter* should be entered as precisely as possible, because otherwise the measurement results are not correct!

There is no uniform standard for the tube *inner diameter*!

(Please inquire it from the manufacturer or measure it by your own!)

### 11.6.1.2 Gas Constant settings

External sensor → Settings → Sensor settings → C1 → arrow right (2.page) → Gas Constant description field

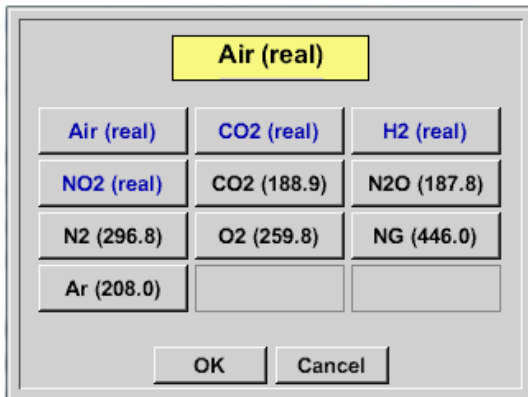

Air (real)		
Air (real)	CO2 (real)	H2 (real)
NO2 (real)	CO2 (188.9)	N2O (187.8)
N2 (296.8)	O2 (259.8)	NG (446.0)
Ar (208.0)		

OK Cancel

All gases marked in blue and with (real) have been a real gas calibration curve stored in the sensor.

Select the gas you require and confirm selection by pressing **OK** button.

#### Attention:

**Reference temperature and reference pressure (factory setting 20 °C, 1000 hPa):**

**All volume flow values (m<sup>3</sup>/h) and consumption values indicated in the display are related to 20 °C, 1000 hPa (according to ISO 1217 intake condition)**

**0 °C and 1013 hPa (= standard cubic meter) can also be entered as a reference.**

**Do not enter the operation pressure or the operation temperature under reference conditions!**

### 11.6.1.3 Definition of the reference conditions

Here, the desired measured media reference conditions for pressure and temperature can be defined

External sensor → Settings → Sensor settings → C1 → arrow right (2.page) → Ref. Pressure description field

External sensor → Settings → Sensor settings → C1 → arrow right (2.page) → Ref. Pressure Unit description field

The image shows two side-by-side screenshots from a device's menu. The left screenshot is titled 'Ref. Pressure' and features a numeric keypad with the value '1000' displayed in a yellow box. Below the keypad are 'OK' and 'Cancel' buttons. The right screenshot shows a unit selection menu with 'mbar' highlighted in a yellow box. Below the unit selection are 'OK' and 'Cancel' buttons.

External sensor → Settings → Sensor settings → C1 → arrow right (2.page) → Ref. Temp. description Field

External sensor → Settings → Sensor settings → C1 → arrow right (2.page) → Ref. Temp. Unit description Field

The image shows two side-by-side screenshots from a device's menu. The left screenshot is titled 'Ref. Temp.' and features a numeric keypad with the value '20' displayed in a yellow box. Below the keypad are 'OK' and 'Cancel' buttons. The right screenshot shows a unit selection menu with '°C' highlighted in a yellow box. Below the unit selection are 'OK' and 'Cancel' buttons.

### 11.6.1.4 Definition Unit of flow and velocity

External sensor → Settings → Sensor settings → C1 → arrow right (2.page) → Flow description Field

External sensor → Settings → Sensor settings → C1 → arrow right (2.page) → Velocity description Field

The image shows two side-by-side screenshots from a device's menu. The left screenshot shows a grid of flow units with 'm³/h' highlighted in a yellow box. Below the grid are 'OK' and 'Cancel' buttons. The right screenshot shows a grid of velocity units with 'm/s' highlighted in a yellow box. Below the grid are 'OK' and 'Cancel' buttons.

### 11.6.1.5 Definition consumption counter value and consumption unit

External sensor → Settings → Sensor settings → C1 → arrow right (2.page) → Count Val. description Field

External sensor → Settings → Sensor settings → C1 → arrow right (2.page) → Count Val. Unit description Field

The sensor allows taking over a starting counter value. Inserting the value by entering the "Count. Val." text field.

In the Count. Val. Unit field different units could be used. Selection by activation of the "Count. Val. Unit" text field

In case the counter value unit will be changed only the consumption counter value will be recalculated to the appropriate unit.

Selection to confirm selection by pressing **OK** button.

**Remark:**

After confirmation with **OK**, the font is black again and the values and settings are accepted

### 11.6.1.6 Settings analogue output 4-20mA of VA 5xx

External sensor → Settings → Sensor settings → C1 → More-Settings → 4-20mA Ch1

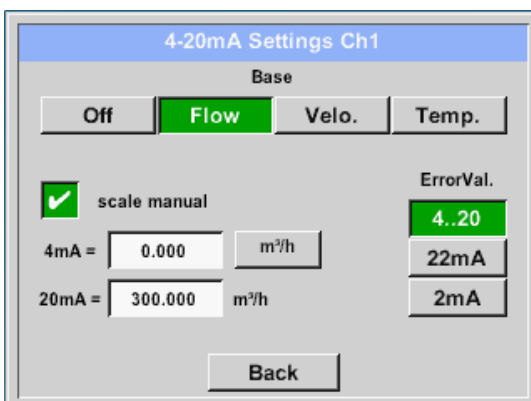
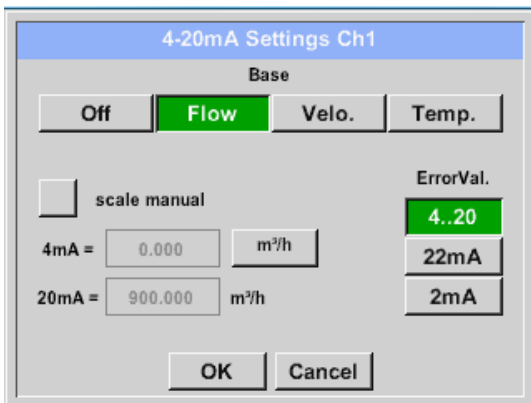
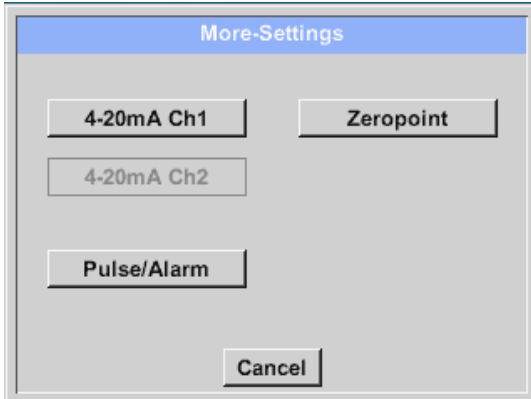

This menu allows the adjustment / assignment of the measurement value and the scaling of the analogue output by pressing the "4-20mA Ch1" button.

Selection of the analogue output measurement value by activating the appropriate measured value key in this example, "Flow".

Possible outputs are flow, velocity and temperature. In case of no use, please select "Off".

The analogue output scaling have to possibilities, automatic scaling (default) and a manual scaling by the user. Auto scaling is based on the calibration settings, means 4mA is set to zero and the 20mA value is based on the max. settings here 900m<sup>3</sup>/h

A "manual scaling" needs an activation of the "scale manual" button.

In text fields "4mA" and "20mA" the appropriate scaling values are entered, here from zero m<sup>3</sup>/h (4mA) to 300 m<sup>3</sup>/h (20mA).

With "Error Val" it is determined what is the output in case of an error at the analogue output.

- 2 mA Sensor error / System error
- 22 mA Sensor error / System error
- 4..20 Output according Namur (3.8mA – 20.5 mA)  
< 4mA to 3.8 mA Measuring range under range  
>20mA to 20.5 mA Measuring range exceeding

Inputs / changes to be confirmed with "OK" button. Return to main menu with "Back".

### 11.6.1.7 Settings Pulse / Alarm output of VA 5xx

External sensor → Settings → Sensor settings → C1 → More-Settings → Pulse / Alarm

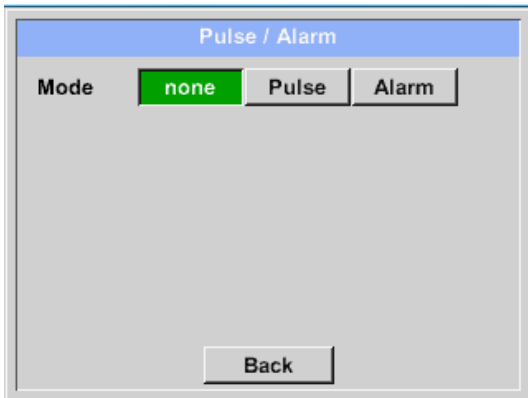

The pulse output of the VA 5xx could be set functionally as pulse output or alarm output.

Function to activate by pressing either the "Pulse" or "Alarm" button.

In case of no use, please select "none".

Inputs / changes to be confirmed with "OK" button. Return to main menu with "Back".

External sensor → Settings → Sensor settings → C1 → More-Settings → Pulse

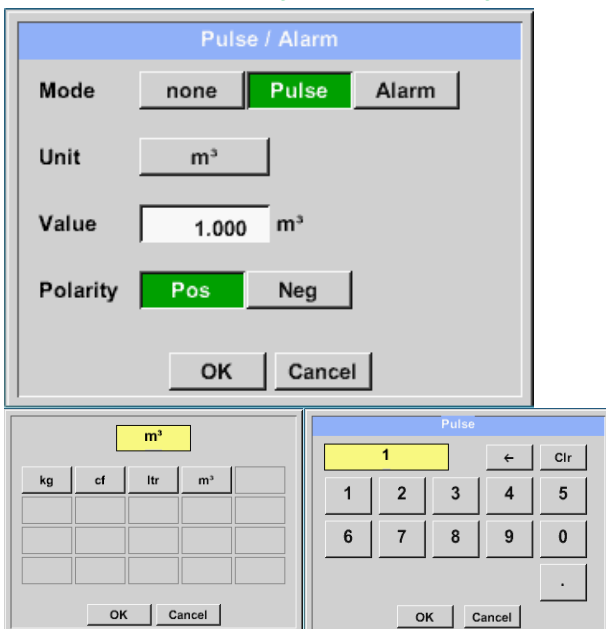

To set up the pulse first the unit and the measurement value have to be defined.

Unit selection by pressing "unit" button and choice one of the possible units "kg", "cf", "ltr" or "m³").

Pulse weight setting by entering the text field "Value".

Here with defined 1 pulse per m³ and with positive polarity.

With „Polarity“ the switching state could be defined.

Pos. = 0 → 1 neg. 1 → 0

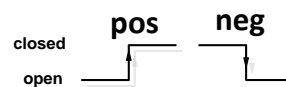

Inputs / changes to be confirmed with "OK" button. Return to main menu with "Back".



External sensor → Settings → Sensor settings → C1 → More-Settings → Alarm

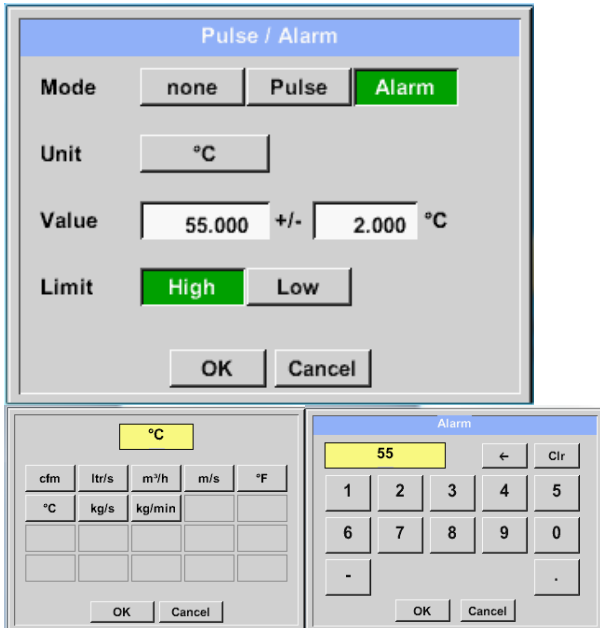

**Pulse / Alarm**

Mode: none Pulse **Alarm**

Unit: °C

Value: 55.000 +/- 2.000 °C

Limit: **High** Low

OK Cancel

**Alarm**

°C

cfm	ltr/s	m <sup>3</sup> /h	m/s	°F
°C	kg/s	kg/min		

OK Cancel

55 ← Clr

1	2	3	4	5
6	7	8	9	0
-			.	

OK Cancel

In case of use the pulse output as alarm following definitions needs to be set:

Unit selection by pressing *“unit”* button and choice one of the possible units *“cfm”, “ltr/s”, “m<sup>3</sup>/h”, “m/s”, “°F”, “°C”, “kg/s” or “, “kg/min”*).

Alarm value setting by entering the text fields *“Value”*.

The limits *„High“* or *„Low“* defines when the alarm is activated, selecting by pressing the appropriate button

**High:** Value over limit

**Low:** Value under limit

Inputs / changes to be confirmed with *“OK”* button. Return to main menu with *“Back”*.

### 11.6.1.8 Settings ZeroPoint or Low Flow Cut off for VA 5xx

External sensor → Settings → Sensor settings → C1 → More-Settings → Zeropoint

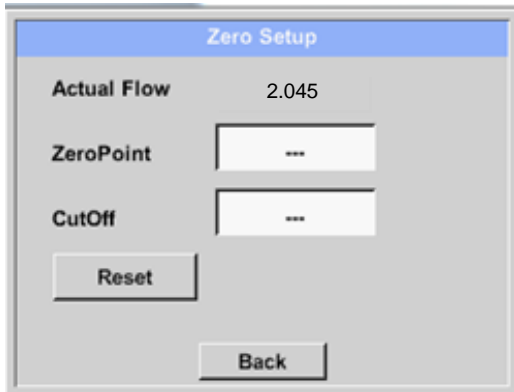

Zero Setup

Actual Flow 2.045

ZeroPoint

CutOff

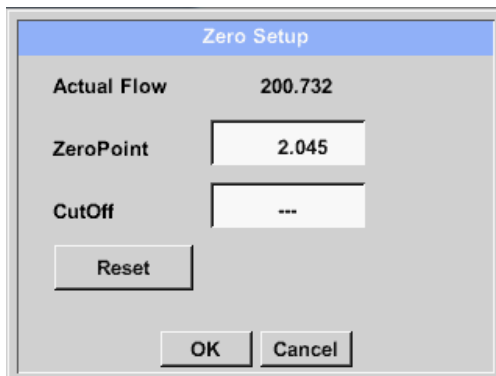

Zero Setup

Actual Flow 200.732

ZeroPoint

CutOff

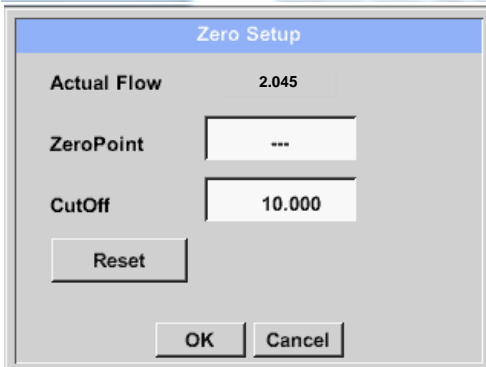

Zero Setup

Actual Flow 2.045

ZeroPoint

CutOff

With these function following adjustments for the sensor VA 5xx could be done.

**Zeropoint:**

When, without flow, the installed sensor shows already a flow value of  $> 0 \text{ m}^3/\text{h}$  herewith the zero point of the characteristic could be reset.

**Cutoff:**

With the low-flow cut off activated, the flow below the defined "LowFlow Cut off" value will be displayed as  $0 \text{ m}^3/\text{h}$  and not added to the consumption counter.

For Zero Point the text field "ZeroPoint" to enter and insert the displayed actual flow, here 2.045.

## 11.7 Type Modbus

### 11.7.1 Selection and activation of Sensor-Type Modbus

**First Step: First step:** choose an unused sensor channel

External sensor → Settings → Sensor settings → C1

**Second step:** choose type Modbus

External sensor → Settings → Sensor settings → C1 → Type description field → Modbus

**Third step:** confirm with *OK*.

External sensor → Settings → Sensor settings → C1 → arrow right (2.page) → Va → use

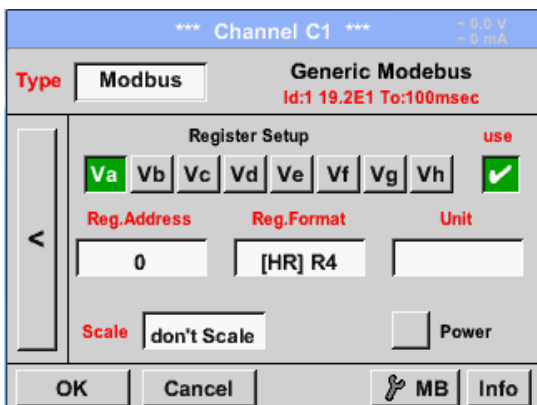

Via Modbus, it is possible to read out up to 8 Register-Values (from Input or Holding Register) of the sensor.

Selection by the Register Tabs *Va –Vh* and activation by pressing of the corresponding *Use* button.

#### 11.7.1.1 Modbus Settings

External sensor → Settings → Sensor settings → C1 → arrow right (2.page) → Modbus Settings → ID -text field

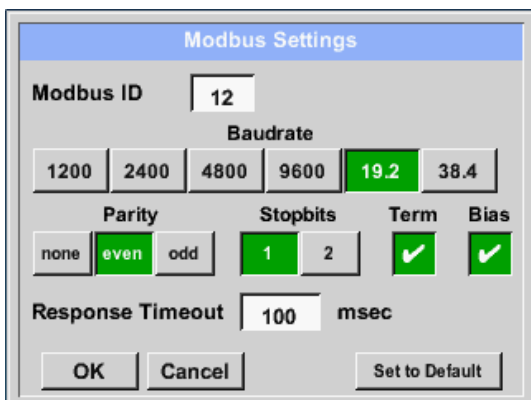

Please insert here the specified *Modbus ID* of the sensor, allowed values are *1 -247*, (e.g. here *Modbus ID = 12*)

For setting the Modbus ID on the sensor, please see sensor-datasheet.

In addition in the menu are the serial transmission settings *Baudrate*, *Stopbit*, *Paritybit* and *Timeout* time to define.

In case that the LD 510 is the end of the RS485 bus system with activating *Term-* & *Bias-* button the required termination and biasing could be activated.

Confirmation by pressing *OK* button.

For resetting to the default values please press *Set to Default*.

External sensor → Settings → Sensor settings → C1 → Reg. Address description field

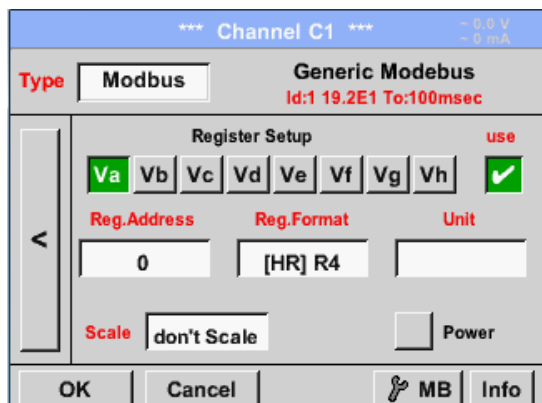

The measurement values are kept in the registers of the sensor and can be addressed via Modbus and read by the PI 500  
 This requires setting the desired register addresses in the LD 510  
 Entering the register / data address is here in decimal with 0-65535.

**Important:**

Required is the correct *register-address*.

It should be noted that the register-number could be different to the register-address (Offset). For this, please consult the sensor data sheet.

External sensor → Settings → Sensor settings → C1 → Reg. Format description field

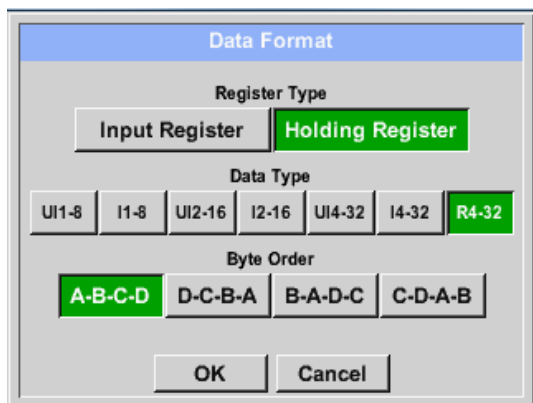

With the buttons *Input Register* and *Holding Register* the corresponding Modbus-register type will be selected.  
 The number format and transmission order of each value needs to be defined by *Data Type* and *Byte Order*. Both have to be applied in correct combination.

**Supported Data types:**

<b>Data Type:</b>	UI1(8b) = unsigned Integer	=>	0	-	255
	I1 (8b) = signed integer	=>	-128	-	127
	UI2 (16b) = unsigned Integer	=>	0	-	65535
	I2 (16b) = signed integer	=>	-32768	-	32767
	UI4 (32b) = unsigned Integer	=>	0	-	4294967295
	I4 (32b) = signed integer	=>	-2147483648	-	2147483647
	R4 (32b) = floating point number				

**Byte Order:**

The size of each Modbus-register is 2 Byte. For a 32 bit value two Modbus-Register will be read out by the LD510. Accordingly for a 16bit Value only one register is read.

In the Modbus Specification, the sequence of the transmitted bytes is not defined clearly. To cover all possible cases, the byte sequence in the LD 510 is adjustable and must adapted to the respective sensor. Please consult here for the sensor datasheet.

e.g.: High byte before Low Byte, High Word before Low Word etc.

Therefore, the settings have to be made in accordance to the sensor data sheet.

**Example:**

Holding Register - UI1(8b) - Value: 18

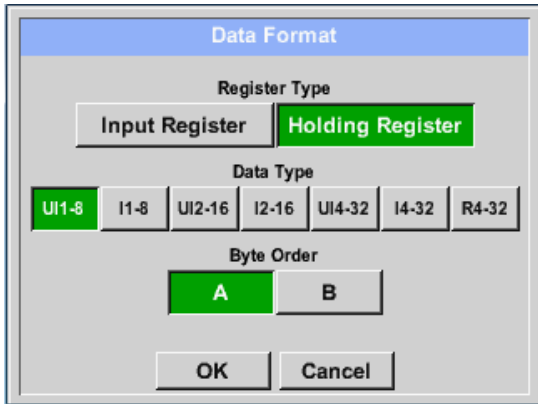

Selection Register Type *Holding Register*,  
Data Type *UI1(8b)* und Byte Order *A / B*

18 =>            HByte   LByte  
                  00     12

Data Order	1. Byte	2. Byte
A	00	12
B	12	00

Holding Register – UI4(32) - Value: 29235175522 → AE41 5652

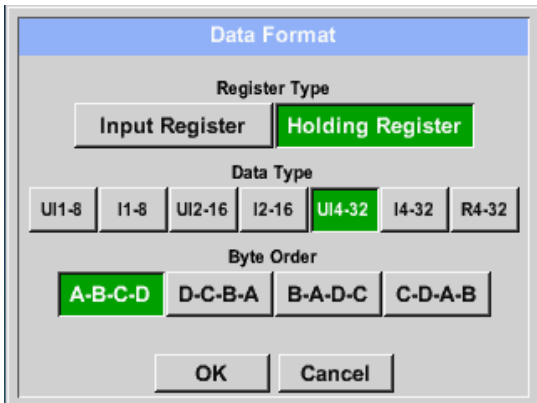

Selection Register Type *Holding Register*,  
Data Type *UI1(32b)* und Byte Order *A-B-C-D*

29235175522 =>            HWord            LWord  
                              HByte   LByte   HByte   LByte  
                              AE     41     56     52

Data Order	1. Byte	2. Byte	3. byte	4. Byte
A-B-C-D	AE	41	56	52
D-C-B-A	52	56	41	AE
B-A-D-C	41	AE	52	56
C-D-A-B	56	52	AE	41

External sensor → Settings → Sensor settings → C1 → Unit- description field

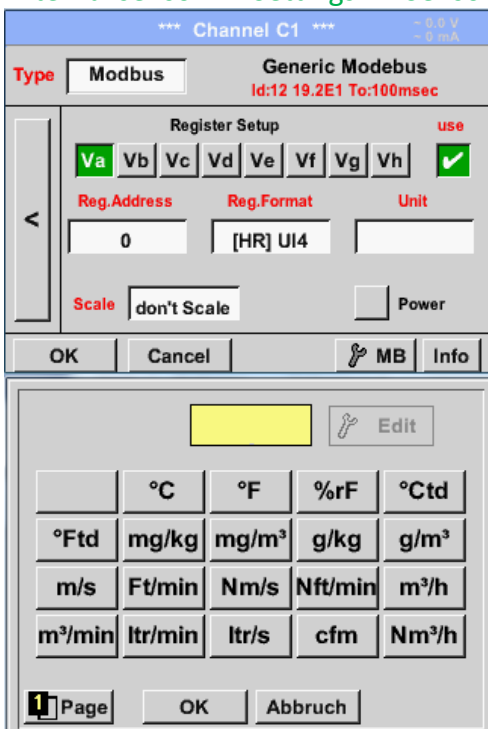

By pressing the description field *Unit* , the list with the available units appear

Please select the unit by pressing the respective button e.g. *m³/h*.

For validation of the unit, please push the button *OK*

To move through the list please press the button *Page*.

In case the unit is **not** available, it is possible to create a user defined unit. Therefore, please select one of the *User\_X* buttons.

External sensor → Settings → Sensor settings → C1 → Scale- description field

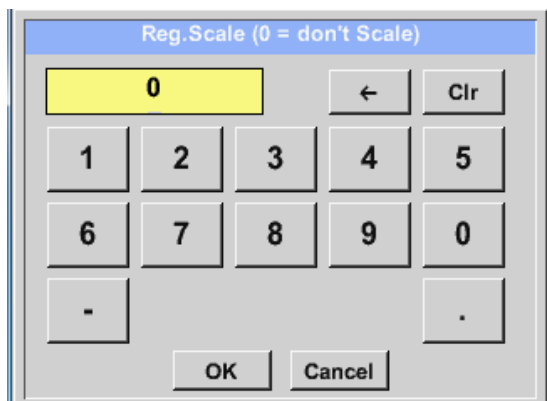

The use of this factor allows adapting the output value by the same.

By default or value = 0 no scaling is applied and displayed in the field is *don't scale*

External sensor → Settings → Sensor settings → C1 → OK

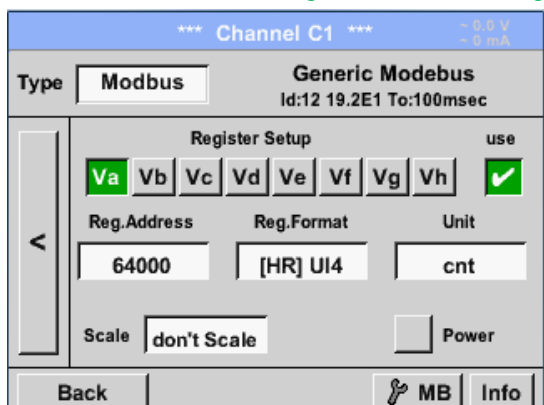

By pressing the *OK* button, the inputs are confirmed and stored.

### 11.8 Data logger Settings

External sensor → Settings → Logger settings

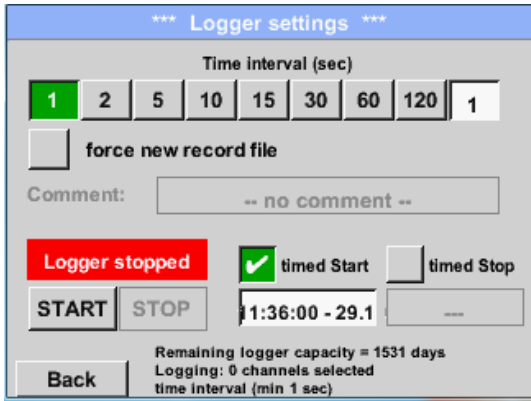

In the top row you can select the predefined *Time intervals* 1, 2, 5, 10, 15, 30, 60 and 120 seconds for recording.

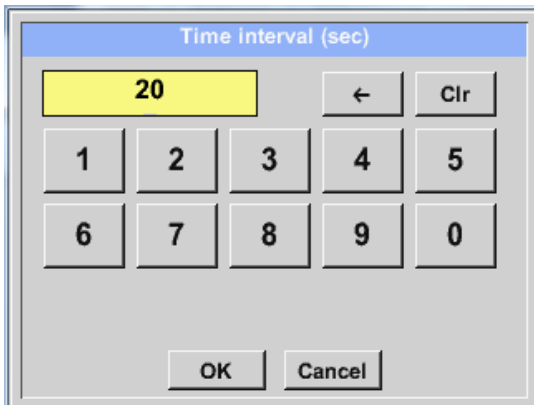

A different, individual *Time interval* can be entered in the highlighted white description field right at the head, where the currently set *Time interval* is always displayed.

**Remark:**  
The largest possible *Time interval* is 300 seconds.

**Remark:**

If more than 12 measurement data are recorded at the same time, the smallest possible time interval of the data logger is 2 seconds.

In addition, if more than 25 measurement data are recorded at the same time, the smallest possible time interval of the data logger is 5 seconds.

External sensor → Settings → Logger settings → force new Record File button

or

External sensor → Settings → Logger settings → force new Record File button → Comment description field

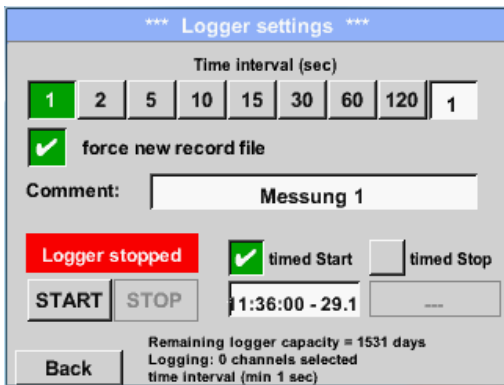
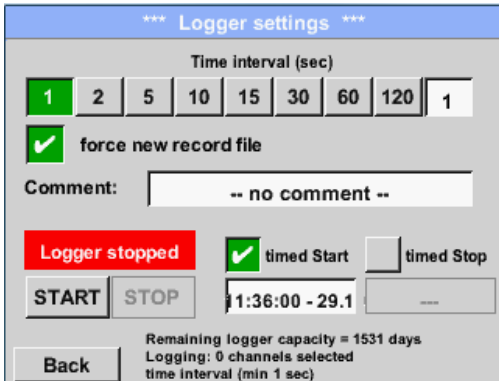

A new recording file will be created by pushing the *force new record file* button and a name or comment can be entered by the choice of the *Comment* description field.

**Important:**

If a new recording file should be created, the *force new record file* button must be activated.

Otherwise, the last applied recording file is used.

Main menu → Settings → Logger settings → timed Start button

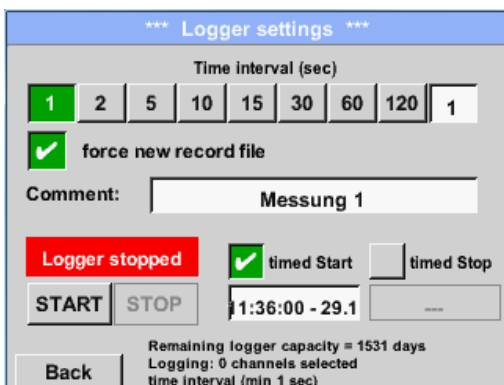

By pushing the *timed Start* button and then the date/time description field below, the date and the start time can be set for a data logger recording.

**Remark:**

If the start time is activated, it will automatically be set at the current time plus a minute.



External sensor → Settings → Logger settings → **timed Stop button**

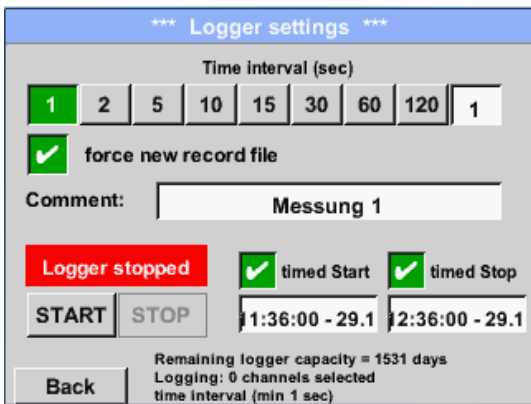

By pushing the *timed Stop* button and then the date/time description field below, the date and the stop time can be set for a data logger recording.

**Remark:**

If the stop time activated, it will automatically be set to the current time plus an hour.

External sensor → Settings → Logger settings → **timed Start button/timed Stop button**  
 → **Date/Time description field**

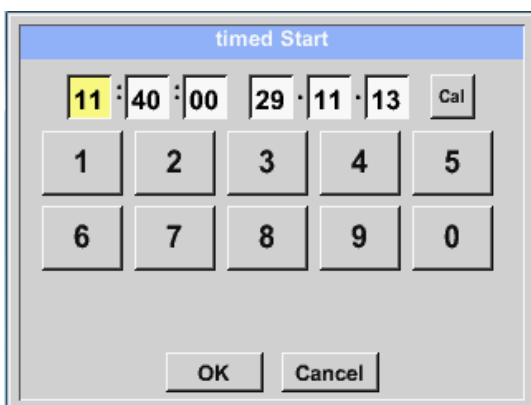

After pushing the *date/time description field* a window will appear where the yellow marked area of the time or date can always be set and changed.

External sensor → Settings → Logger settings → timed Start button/timed Stop button  
 → Date/Time description field → Cal button

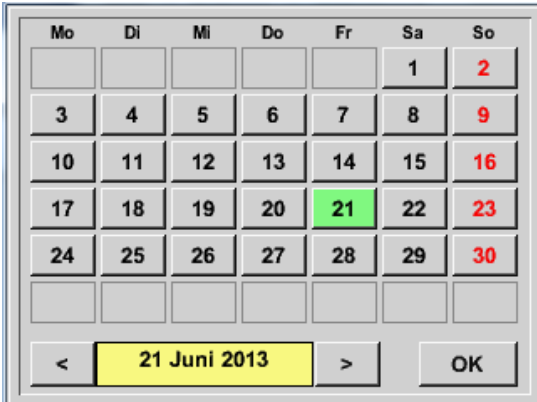

With the *Cal* button the desired date can be easily select from the calendar.

External sensor → Settings → Logger settings → Start button

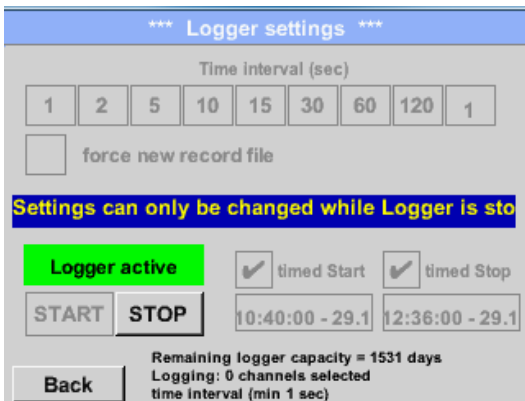

After the start and stop time activation and the created settings, the *Start* button will be pushed and the data logger is armed.

The data logger starts the recording at the set time!

External sensor → Settings → Logger settings → Start button/Stop button

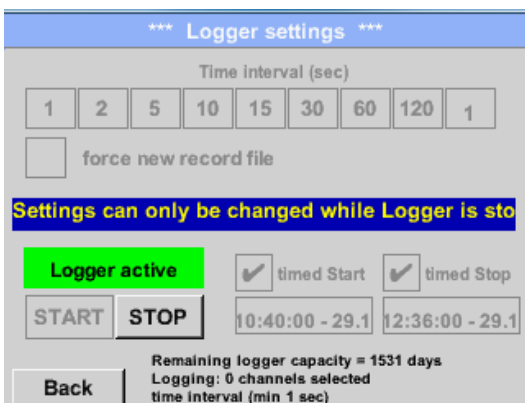

The data logger can be started without activated time settings, use the *Start* and *Stop* buttons for activate and disable.

Left below there will be shown how many values are recorded and how long there still can be recorded.

**Remark:**  
 The settings cannot be changed, if the data logger runs.

**Important:**

If a new recording file should be created, the *force new record file* button must be activated. Otherwise, the last applied recording file is used.

## 12 Scope of delivery

The LD 500 is available either as a single unit or in a set. The set contains all the components and accessories that are protected in a rugged and shock-resistant transport case.



The following table lists the components with their order numbers.

Description	Order No.
<b>Set LD 500 consisting of:</b>	<b>0601 0105</b>
LD 500 leak detector with acoustic trumpet, and integrated camera, 100 leak tags for marking the leakages on site	0560 0105
Sound-proof headset	0554 0104
Focus tube with focus tip	0530 0104
Battery charger(AC adapter plug)	0554 0009
Transportation case	0554 0106
Helix cable for connecting the ultrasonic sound sensor	0200 01402
Gooseneck for leak detection in hard-to-reach areas (optional)	0530 0105
Parabolic mirror for leak detection at long distances (optional)	0530 0106



### **13 Appendix**

In the appendix on the following pages you will find the Declaration of Conformity for the electromagnetic compatibility and the Test Report of the Li-ion batteries used.



# KONFORMITÄTSERKLÄRUNG

DECLARATION OF CONFORMITY

Wir CS Instruments GmbH & Co.KG  
We Am Oxxer 28c, 24955 Harrislee

Erklären in alleiniger Verantwortung, dass das Produkt  
Declare under our sole responsibility that the product

**Leckage-Suchgeräte mit Kamera LD 500 / LD 510**  
Leak meters with camera LD 500 / LD 510

den Anforderungen folgender Richtlinien entsprechen:  
We hereby declare that above mentioned components comply with requirements of the following EU directives:

Elektromagnetische Verträglichkeit Electromagnetic compatibility	2014/30/EU 2014/30/EC
RoHS (Restriction of certain Hazardous Substances)	2011/65/EC

Angewandte harmonisierte Normen:  
Harmonised standards applied:

EMV-Anforderungen EMC requirements	EN 55011: 2011-04 EN 61326-1: 2013-07
---------------------------------------	--

Anbringungsjahr der CE Kennzeichnung: 18  
Year of first marking with CE Label: 18

Das Produkt ist mit dem abgebildeten Zeichen gekennzeichnet.  
The product is labeled with the indicated mark.



Harrislee, den 12.02.2018

  
Wolfgang Blessing Geschäftsführer

Diese Erklärung beinhaltet keine Zusicherung von Eigenschaften.  
Die Sicherheitshinweise der mitgelieferten Produktdokumentation sind zu beachten.





报告编号(Report ID): H11133012221D~1

## 锂电池UN38.3测试报告

### Lithium Battery UN38.3 Test Report

样品名称 (Sample Description)	Lithium-ion Battery 238700
委托单位 (Applicant)	Jauch Quartz GmbH-Batteries
生产单位 (Manufacturer)	Jauch Quartz GmbH-Batteries



**PONY 谱尼测试**  
Pony Testing International Group  
[www.ponytest.com](http://www.ponytest.com)

No.: H11133012221D  
Code: ssak93kqv

13-DUW-2

Report ID: H11133012221D~1 Page 1 of 11



Pony Testing International Group

I. SAMPLE DESCRIPTION

Sample Name	Lithium-ion Battery		Battery Type	238700	
Client	Jauch Quartz GmbH-Batteries				
Manufacturer	Jauch Quartz GmbH-Batteries				
Nominal Voltage	7.2V	Rated Capacity	2600mAh	Limited Charge Voltage	8.56±0.025V
Charge Current	1250mA	Maximum Continuous Charge Current	2600mA	End Charge Current	100mA
Cut-off Voltage	5.5V	Maximum Discharge Current	5200mA	Use	---
Cells Number	2PCS	Cell Model	18650	Rated Capacity	2600mAh
Manufacturer of cell	Samsung SDI Co., Ltd				
Chemical component	Li-Ion				
Client date	2013-11-12		Finished date	2013-12-02	

II. REFERENCE METHOD

《United Nations Recommendations On The Transport Of Dangerous Goods, Manual Of Tests And Criteria》(ST/SG/AC.10/11/Rev.5/Amend.1).

III. TEST ITEM

- |                        |                           |
|------------------------|---------------------------|
| 1. Altitude simulation | 5. External short circuit |
| 2. Thermal test        | 6. Impact                 |
| 3. Vibration           | 7. Overcharge             |
| 4. Shock               | 8. Forced discharge       |

IV. CONCLUSION

ITEM	SAMPLE NUMBER	STANDARD	CONCLUSION
Altitude simulation	N1~N4 C1~C4	UN38.3	PASS
Thermal test			PASS
Vibration			PASS
Shock			PASS
External short circuit	N9~N13		PASS
Impact			PASS
Overcharge	N5~N8 C5~C8		PASS
Forced discharge	N14~N23 C9~C18		PASS

The submitted battery and component cell were complied with the UN Manual of Tests and Criteria, Part III, sub-section 38.3.

Prepared by: *Feng Wei Kun*

Checked by: *chengpeng* Approved by: *P. Jiao*

Approval Date: December 2, 2013

**PONY 谱尼测试**  
Pony Testing International Group

www.ponytest.com ☎Hotline 400-819-5688

Add: 北京市海淀区东升园19-3号蓝智大厦	Add: 上海市徐汇区桂平路690号35号B412	Add: 深圳市南山区创业路中兴工业城4楼	Add: 青岛市崂山区苗圃路199号B6
Tel: (010) 82018118	Tel: (021) 64951999	Tel: (0755) 26009000	Tel: (0532) 80796900
Add: 天津市南开区红桥区南开区	Add: 宁波市高新区新明路150号101号B12	Add: 广州市番禺区南村街189号	Add: 珠海市拱北口岸25号B25
Tel: (022) 27160730	Tel: (0574) 8776499	Tel: (020) 89224318	



## SALES OFFICE NORD



CS INSTRUMENTS GmbH & Co. KG

Am Oker 28c  
D-24955 Harrislee  
DEUTSCHLAND  
Tel.: +49 (0) 461 80 71 50 - 0  
Fax: +49 (0) 461 80 71 50 - 15

[info@cs-instruments.com](mailto:info@cs-instruments.com)

[www.cs-instruments.de](http://www.cs-instruments.de)

## SALES OFFICE SOUTH



CS INSTRUMENTS GmbH & Co. KG

Zindelsteiner Straße 15  
D-78052 VS-Tannheim  
DEUTSCHLAND  
Tel.: +49 (0) 7705 978 99-0  
Fax: +49 (0) 7705 978 99-20

[info@cs-instruments.com](mailto:info@cs-instruments.com)

[www.cs-instruments.de](http://www.cs-instruments.de)